

Integrated Remote Commander

Operating Instructions

RM-AV3000

WARNING

To prevent fire or shock hazard, do not expose the unit to rain or moisture.

To avoid electrical shock, do not open the cabinet. Refer servicing to qualified personnel only.

WARNING

You are cautioned that any changes or modifications not expressly approved in this manual could void your authority to operate this equipment.

For the customers in the USA

Owner's Record

The model number is located on the front panel.

The serial number is located on the inner side of the battery compartment.

Record these numbers in the spaces provided below. Refer to them whenever you call upon your Sony dealer regarding this product.

Model No. RM-AV3000

Serial No. _____

NOTICE FOR THE CUSTOMERS IN THE U.S.A.

NOTE

This equipment has been tested and found to comply with the limits for a Class B digital device, pursuant to Part 15 of the FCC Rules. These limits are designed to provide reasonable protection against harmful interference in a residential installation. This equipment generates, uses, and can radiate radio frequency energy and, if not installed and used in accordance with the instructions, may cause harmful interference to radio communications. However, there is no guarantee that interference will not occur in a particular installation. If this equipment does cause harmful interference to radio or television reception, which can be determined by turning the equipment off and on, the user is encouraged to try to correct the interference by one or more of the following measures:

- Reorient or relocate the receiving antenna.
- Increase the separation between the equipment and receiver.
- Connect the equipment to an outlet on a circuit different from that to which the receiver is connected.
- Consult the dealer or an experienced radio/TV technician for help.

You are cautioned that any changes or modifications not expressly approved in this manual could void your authority to operate this equipment.

Features

The RM-AV3000 Remote Commander provides centralized control of all your AV components from a single remote commander and saves the trouble of operating different AV components with different remote control devices. The following are its main features.

Customizing 258 labels of control keys in the dot matrix

LCD with dot matrix makes label customizing possible. A total of 258 labels on the LCD, such as component labels, macro labels, etc., can be customized. A label of up to 8 letters with digits, characters or symbols can be selected and displayed.

Control of 18 components

Control of a maximum of 18 components (TV, STB, VCR, DVD, CD, AMP, etc.) is possible.

Components are selectable with 6 buttons on the Commander for the components frequently used and 12 keys on the LCD (displayed by pressing the OTHER button). Component Select buttons of light storage type are easy-to-operate and visible in the dark.

Setting a maximum of 45 macro commands of a maximum of 32 successive steps

A maximum of 45 macro commands which provide a maximum of 32 successive steps by pressing a single button can be set (15 system control macros, 18 component macros, and 12 timer macros). Macro execution speed is changeable. All power on/off macro commands for Sony components are preset at the factory.

Clock display and timer function

Using a maximum of 12 timer macros, timer control of automatic on/off and other controls (such as recording, stopping, etc.) of each component are possible.

Centralized control of Sony AV components with this one remote commander

This Commander is preset at the factory to operate Sony brand components, so you can use it out of the box as a control center for your Sony AV components.

Remote control signals for non-Sony components are also preset

This Commander is preset for most major brands components including Sony. You can remote control your components by setting their code numbers (page 12).

Learning function for programming other remote control signals you need

This Commander has a learning function, to learn remote control signals to operate non-preset components or functions (page 19).

In addition, the Commander can learn remote control signals (infrared signals only) of non Audio Visual components such as air-conditioners, lights, etc. (some specific appliances or functions may not be available) (page 49).

Channel macro function allows you to select a channel with a single key

Up to 4 key steps can be programmed on macro keys (Label keys). If you set the key operations for entering a channel number on a macro key, you can select the channel by pressing that macro key (page 58).

Easy-to-operate touch key LCD with blue back light

This Commander has a touch key LCD that changes the key display according to the selected component. The Commander is easy to operate as only the keys necessary to operate the selected component are displayed. The display backlight allows operation even in the dark.

Table of Contents

Getting Started

Location and Function of Controls	6
Installing the Batteries	7
When to replace the batteries	8
Setting the Clock	8
Setting the clock for the first time after installing batteries	8
Adjusting the clock after setting the clock	10

Basic Operations

Setting the Code for Preset Audio and Visual Components	12
Setting a component code	12
Checking if the code number works	15
Finding a component code with the Search function	16
Operating Your Components with the Remote Commander	18
To control the volume	19
Using Non-Preset Remote Control Operations — Learning Function	19
For accurate learning	25
Changing or erasing the function of a taught key or button	25

Advanced Features

Controlling the Volume of Visual Components Connected to an Audio System	29
Executing a Series of Commands — System Control Functions	31
Programming a series of commands for the SYSTEM CONTROL buttons or the Label keys	32
Notes on System Control Operations	37
Programming a series of commands for the Component Select buttons or the Label keys	38
Changing the interval between operation steps	40
To change the component macro executing time	42
Adding an Extra Function to the Component Select Buttons	43
Programming the Power-On command of the selected component (for Sony components only)	43
Adding a command that is required when selecting a component	45
Assigning Other Components to the Component Select Buttons or the Label keys	47
Copying the settings of a Component Select button or a Label key to another button or key	47
Programming a Frequently Used Key Operation for SYSTEM CONTROL Buttons or Label Keys	49
Notes on learning the signals of an air-conditioner	52
Transferring Data between Commanders	52
Transferring data	52
Receiving the data	56

Selecting a Channel with a Single Key Press — Channel Macro Function	58
Setting the Timer	61
Setting the new timer program	61
Changing the program already set or changing another program that you select	65

Using Other Functions

Locking the Controls — Hold Function	71
Protecting your settings — Setting Lock Function	72
Setting the Automatic-Off Time of the Display Window	73
Adjusting the Backlight of the Display Window	74
Setting the Key-Touch Beep	77
Adjusting the Contrast of the Display Window	78
Changing the Names of the Label Keys or the Component Names on the Mode Display Key	79
Erasing All the Settings	81

Additional Information

Precautions	83
Maintenance	83
Specifications	83
Troubleshooting	84

Appendix

Table of Preset Functions	88
TV	88
STB (Digital satellite)	89
STB2 (Digital cable box)	90
VCR, VCR2, VCR3	91
DVD, DVD2	92
CD	93
AMP	94
MD	95
TAPE A, TAPE B	96
CABLE (Cable box)	97
LD (Laser disc player)	97
DVR (Digital video recorder)	98
DAT	99
LIGHTING	100
Quick Reference of Operations	101
Full display	103
Index	Back cover

Location and Function of Controls

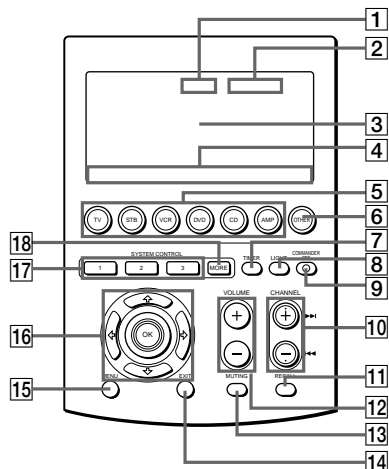

1 Clock Display key (page 8)

Displays the clock, the transmission mark, the battery mark and the timer mark.

2 Mode Display key (page 8, 13, 20, 30, 32, 40)

Displays the status of the selected mode.
Function of the key changes according to the selected mode.

3 LCD touch key display

The keys used for operating each component and setting the Commander are displayed.

Note

Do not press the touch keys using sharp objects such as pins or ball-point pens.

4 Label keys (page 8, 13, 20, 23, 30, 32, 40, 79)

The selected modes (up to 8 characters in each Label Key) are displayed. Labels change in the order from the first stage to the third stage and come back to the first, and so on, each time you press the Mode Display key, OTHER, MORE, or TIMER button according to the selected mode.

5 Component Select buttons (page 12)

Selects the component to control.

6 OTHER button (page 13)

Label keys change in the order from the first stage to the third stage and come back to the first, and so on, each time you press the OTHER button when the selected component name is displayed on the Label keys.

7 TIMER button (page 68)

Used to set the timer program, and to set the timer program on or off.

8 LIGHT button (page 76)

Used to light up the LCD display in the dark. Press the button once to turn on the light, and once again to turn it off.

9 COMMANDER OFF button

Turns the power of the Commander off. Then all the display contents are turned off.

10 CHANNEL +/- buttons (page 88, 89, 90, 91)

Select the channel.

11 RECALL button (page 88)

12 VOLUME +/- buttons* (page 19, 29)

Adjust the volume.

13 MUTING button* (page 19, 31)

Mutes the audio. Press the button once again to resume at the previous volume.

- 14 EXIT button (page 89)**
Used to exit the setting menu.
- 15 MENU button (page 88)**
Calls up the menu display of the buttons or keys that have menu function.
- 16 OK button and Cursor Control buttons (page 9, 64, 88)**
- 17 SYSTEM CONTROL buttons (page 31)**
You can program up to 32 consecutive key operations to each of the three SYSTEM CONTROL buttons. You can automatically carry out the entire program by pressing one button.
- 18 MORE button (page 32)**
Label keys change in the order from the first stage to the third stage and come back to the first, and so on, each time you press the MORE button in the system mode.

*** Note on the VOLUME +/- and MUTING buttons**

The Commander controls or mutes the TV's volume when you select a visual component. The Commander controls or mutes the amplifier's volume when you select an audio component.

You can change this setting also (page 29).

Note on the power on and off of the display of the Commander

To turn on the display, press any button except the COMMANDER OFF button.

To turn off the display, press COMMANDER OFF, or if you don't use the Commander, the display automatically turns off after 10 minutes. This interval can also be changed (page 74).

Installing the Batteries

Slide open the battery compartment lid and insert four size AA (R6) alkaline batteries (not supplied). Be sure to line up the + and - on the batteries with the + and - on the battery compartment.

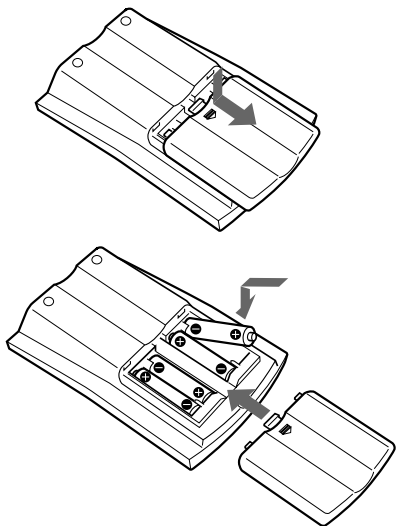

When to replace the batteries

Batteries for remote control operation and backlight (four size AA (R6) batteries)

Under normal conditions, alkaline batteries will last up to 5 months. If the Commander does not operate properly, alkaline batteries might be worn out and  is displayed on the LCD touch panel. When the display dims or the backlight for the touch keys grows dim, replace the alkaline batteries with new ones.

Notes on batteries

- Do not mix old batteries with new ones or mix different types of batteries together.
- If the electrolyte inside the battery should leak, wipe the contaminated area of the battery compartment with a cloth and replace the old batteries with new ones. To prevent the electrolyte from leaking, remove the batteries when you plan not to use the Commander for a long period of time.
- After replacing batteries, set the clock (page 8).

Setting the Clock

Setting the clock for the first time after installing batteries

For the first time after installing batteries, the Commander is in the clock setting mode. “CLOCK” is displayed on the Mode Display key, and “--:--” flashes on the Clock Display key, and “STD TIME” and “DS TIME” on the Label keys are flashing.

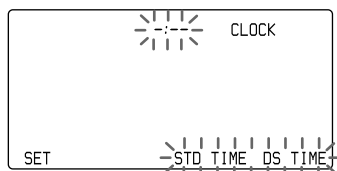

- 1 Select STD TIME (standard time) or DS TIME (daylight saving time). If the summer time (daylight saving time) is used in your area, press the DS TIME key when it is in the summer time. If not, press the STD TIME key.
If the summer time is not used in your area, press the STD TIME key.

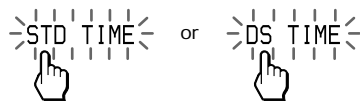

The selected STD TIME or DS TIME key lights.

“SET” and “SU” flash and “12:00 AM” lights on the Clock Display key.

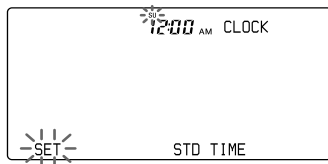

2 Set the day of the week.

Select the day of the week by pressing the \leftarrow or \rightarrow button.

Selected day of the week flashes.

SU : Sunday
MO : Monday
TU : Tuesday
WE : Wednesday
TH : Thursday
FR : Friday
SA : Saturday

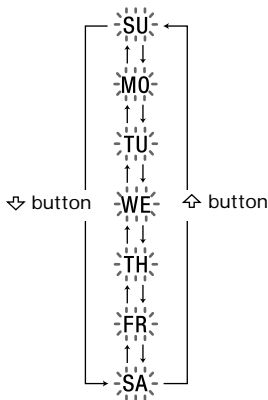

Then press the \rightarrow button. The day of the week is set.

"12", "AM" and "SET" flash.

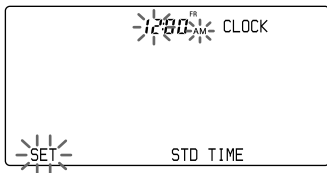

Note

If you press the \leftarrow button, the day of the week is set and setting mode skips to Step 4.

3 Set the hour and AM (or PM) by pressing the \leftarrow or \rightarrow button.

The selected hour and AM (or PM) flash.

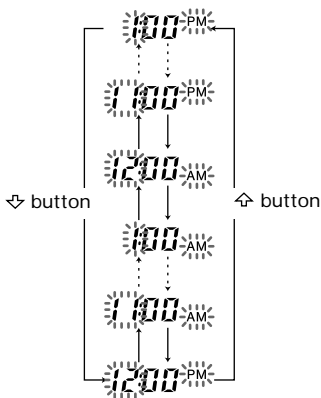

Then press the \rightarrow button. The hour and AM (or PM) are set.

"00" (minute) and "SET" flash.

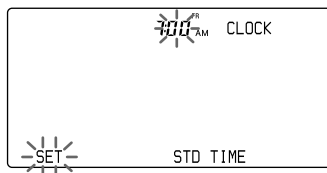

Note

If you press the \leftarrow button, the hour and AM (or PM) are set and the setting mode returns to Step 2.

Setting the Clock (continued)

- 4 Set the minute by pressing the ↕ or ↖ button.

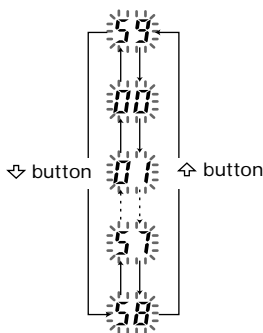

The selected minute flashes.

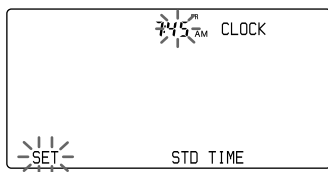

Notes

- If you press the ↕ button, the minute is set and the setting mode returns to Step 2.
- If you press the ↖ button, the minute is set and the setting mode returns to Step 3.
- If you want to finish the clock setting, go to Step 5.

- 5 Press the SET key.

The clock starts from 0 second.

Note

If you press the SET key in any step above, the clock is set then. The clock starts from 0 seconds.

Adjusting the clock after setting the clock

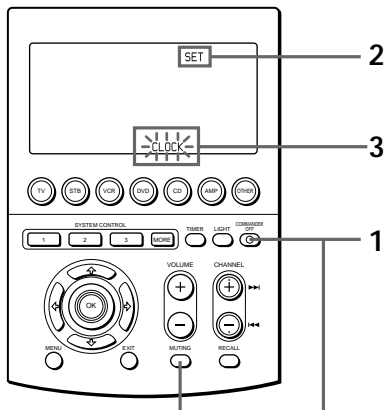

- 1 While pressing COMMANDER OFF, press MUTING.



"SET" appears on the Mode Display key.

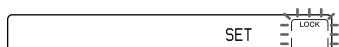

- 2 Press the Mode Display key (SET) twice.

SET



Each time the SET key is pressed, the Label keys change as follows.

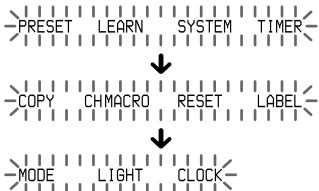

“CLOCK” appears and flashes on one of the Label keys on the display.

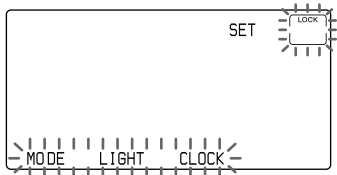

3 Press the CLOCK key.



The Commander enters clock setting mode.

“CLOCK” appears on the Mode Display key, and the current time flashes.

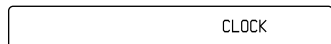

To select STD TIME (standard time) or DS TIME (daylight saving time)

When the Commander enters the clock setting mode when the clock is already set, the time mode previously set (STD TIME or DS TIME) stays lit and the other time mode flashes, and the setting mode goes to Step 4.

If you want to change the time mode, press the flashing key (STD TIME or DS TIME). The selected STD TIME or DS TIME key lights, and the setting mode goes to Step 4. If you do not want to change the time mode, press the \uparrow or \downarrow button. The setting mode goes to Step 4.

When the time mode is changed from STD TIME to DS TIME

The time of the clock returns by one hour.

When the time mode is changed from DS TIME to STD TIME

The time of the clock advances by one hour.

4 To set the clock, follow Steps 2 - 5 on page 9-10.

Note

If you press the SET key in Step 3 or 4, the clock is set then. The clock starts from 0 second.

Setting the Code for Preset Audio and Visual Components

The Commander is preset at the factory to operate Sony brand AV components (see the table below). If you are using the Commander with a factory-set Sony components, skip the following procedures.

You can use the Commander with other preset AV components also. To use with other AV components, you need to follow the procedures to set the correct codes for each component.

Component Select Button	Preset component	Factory setting
TV	TV	Sony TV
STB	Digital satellite	Sony digital satellite
VCR	VCR	Sony VHS VCR (VTR3)
DVD	DVD player	Sony DVD player
CD	CD player	Sony CD player
AMP	Amplifier	Sony amplifier

Label key	Preset component	Factory setting
MD	MD deck	Sony MD deck
TAPE A	Cassette deck*	Sony cassette deck
TAPE B	Cassette deck*	Sony cassette deck
CABLE	Cable box	Cable box
VCR2	VCR	Sony 8mm VCR (VTR2)
VCR3	VCR	Sony Beta VCR (VTR1)
STB2	Digital cable box	Sony digital cable box
DVR	Digital video recorder	Sony digital video recorder

Label key	Preset component	Factory setting
DVD2	DVD player	Sony portable DVD player
LD	LD player	Sony LD player
DAT	DAT deck	Sony DAT deck
LIGHTING	Light	Light

* Analog audio compact cassette deck

See “Table of Preset Functions” (page 88) for the functions of keys and buttons as for each component.

Setting a component code

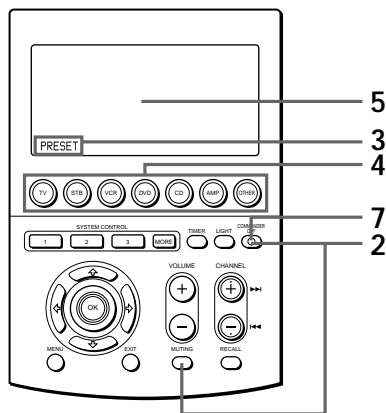

Example: To set up a Philips' TV

- 1 See the tables in the supplied "Component Code Numbers," and find the four-digit code number for the desired component.

If more than one code number is listed, use the number that is listed first.

For example, to set up a Philips TV, you would use the code number 8056. The first digit of the component code number means the component category (TV, VCR, etc.). For further details, see the tables in the supplied "Component Code Numbers."

- 2 While pressing COMMANDER OFF, press MUTING.



"SET" appears on the Mode Display key.

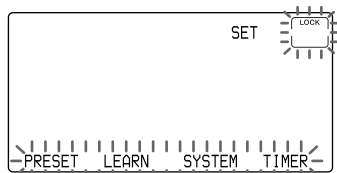

- 3 Press the PRESET key.



"PRESET" appears on the Mode Display key.

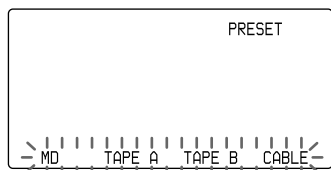

- 4 Select the desired component by pressing the Component Select button or the Label key.



To change the Label keys, press the OTHER button repeatedly. Each time you press the OTHER button, the display of the Label keys changes as follows.

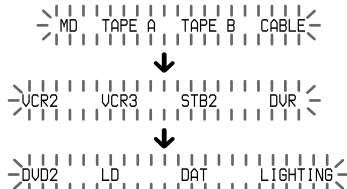

When the desired component is selected, the component name previously preset to the Component Select button or the Label key (in this case, TV), and the four-digit component code number previously set to the component are displayed. "0" - "9," "ENTER," "CLEAR" and "POWER" flash.

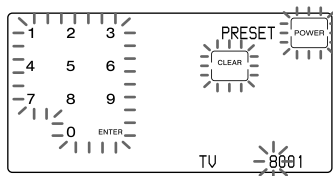

Setting the Code for Preset Audio and Visual Components (continued)

- 5 Press the four-digit component code number followed by the ENTER key on the touch-key display.

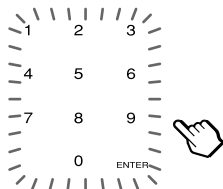

Example: To enter "8056"
Input "8," "0," "5," "6," and press "ENTER".

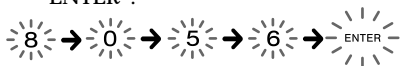

If you press the CLEAR key during inputting the digits

Input digits are canceled. The four-digit component code number previously set is displayed, and the cursor returns to the first digit.

When the setting of the code succeeded

The selected component name, the preset four-digit component code number and "OK" light while a beep sounds. And the display returns to Step 3.

- 6 If you want to set a code for another component, repeat Steps 4 and 5.

- 7 Press COMMANDER OFF.



If you keep COMMANDER OFF pressed for more than 2 seconds
The Commander turns off.

If you keep COMMANDER OFF pressed for less than 2 seconds
The Commander returns to the previous setting mode.

Notes

- If you press a component code number that is not on the table in the supplied "Component Code Numbers", the Commander beeps five times and "NG" flashes after you press the ENTER key. The setting returns to the previous one. If this happens, check the component code number, and try setting again.
- If you don't input anything into the Commander for over two minutes between each step, the setup procedure will be canceled. To set the code, you must again press MUTING while pressing COMMANDER OFF.
- The first digit of the component code number means the component category (TV, VCR, etc.). The component corresponding to the four-digit component code number is preset in Step 5. If you preset the component of which category is different from that preset previously to the Component Select button or the Label key, you can, if necessary, change the component names on the Mode Display key or the Label keys (see page 79).
- If you preset a component code after you input character contents to the Mode Display key (page 24) or the Label keys (page 23), they are cleared and return to the original display. Edit the characters after you decide the component to be used by presetting a code.

Checking if the code number works

- 1 Press the corresponding Component Select button or the Label key for the component you have set up.

To display and change the Label keys, press the OTHER buttons repeatedly.



The Commander turns on and the touch-keys appear on the display.

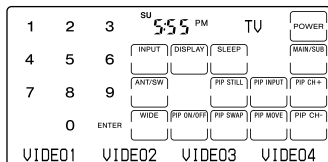

-
- 2 Turn on the component by its power switch.

- 3 Aim the Commander at the component and press the POWER key in the touch-key display.



When the remote control signal is sent,  is shown on the display.

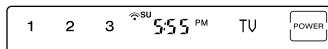

The component should turn off.

-
- 4 If you have succeeded, check that the Commander is operating the other functions of your component, such as channel and volume control.
See page 18 for details.

-
- 5 Press COMMANDER OFF.

COMMANDER
OFF



If you keep COMMANDER OFF pressed for more than 2 seconds
The Commander turns off.

If you keep COMMANDER OFF pressed for less than 2 seconds
The Commander returns to the previous setting mode.

If the Commander does not seem to be working

Try repeating these setup procedures using the other codes listed for your components (see page 12).

Notes on keys which have "learned" a remote control signal already

If another signal has already been programmed on that key or button by the learning function (page 19), that "learned" signal will apply even after you set the component code number. To use it as a preset component key or button, first erase its learned signal (page 25).

Setting the Code for Preset Audio and Visual Components (continued)

Finding a component code with the Search function

You can find a code number available for a component that doesn't have one in the supplied "Component Code Numbers".

Before starting the Search function

Set each component to the following status to enable the Search function.

TV, AMP: Power-on

CD, MD, TAPE, DAT: Power-on with a playback source (disc, cassette tape, etc.)

LIGHTING: Light-on

Other components: Power-off

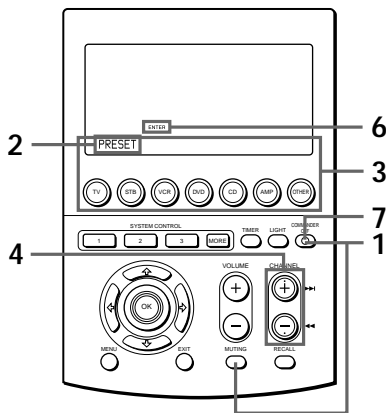

- 1 While pressing COMMANDER OFF, press MUTING.



"SET" appears on the Mode Display key.

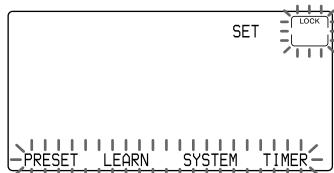

- 2 Press the PRESET key.



"PRESET" appears on the Mode Display key.

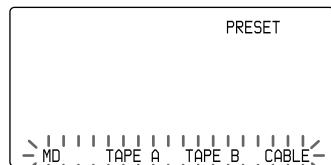

- 3 Select the desired component by pressing the Component Select button or the Label key.



To change the Label keys, press the OTHER button repeatedly. Each time you press the OTHER button, the display of the Label keys changes as in Step 4 on page 13.

When the desired component is selected, the component name previously preset to the Component Select button or the Label key (in this case, TV) and the four-digit component code number previously set to the component is displayed.

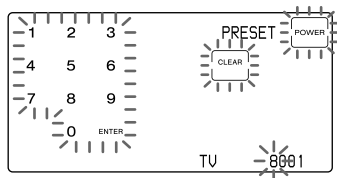

- 4 Press CHANNEL + or CHANNEL - to search component code numbers in the same category (in this case, code numbers which begin with “8”). Press CHANNEL + to go to the next code number. Press CHANNEL - to go back to the previous code number.

CHANNEL

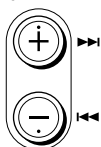

Note

To search component code numbers in another category, return to Step 3, or input a four-digit component code number of another category (for example, a code number which begins with “3”, “4”, etc.) before Step 4.

- 5 Aim the Commander at the component and press the POWER key.



When the remote control signal is sent,  is shown on the display.

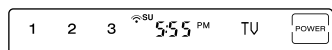

If it successfully works (power-off for TV, AMP, playback for CD, MD, DAT, TAPE, light-off for LIGHTING and power-on for other components), go to Step 6.

If it doesn't, repeat Steps 4 to 5.

- 6 Press the ENTER key.

A beep sounds, and the selected component name, the preset four-digit component code number and “OK” light for two seconds. And the display returns to Step 2.



Note

It is recommended to write down the code number.

- 7 Press COMMANDER OFF.

COMMANDER
OFF



If you keep COMMANDER OFF pressed for more than 2 seconds
The Commander turns off.

If you keep COMMANDER OFF pressed for less than 2 seconds
The Commander returns to the previous set mode.

Operating Your Components with the Remote Commander

When you operate a non-Sony component, make sure you set the component code first (page 12).

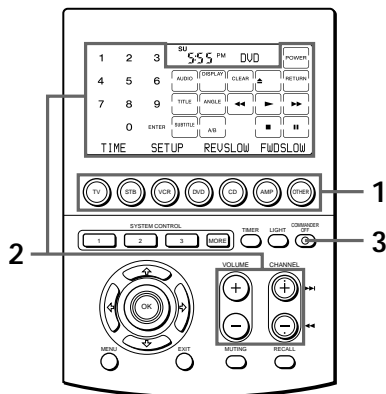

Example: To play a DVD player

- 1 Press the corresponding Component Select button or the Label key for the component you have set up.
To display and change the Label keys, press the Mode Display key repeatedly.



The Commander comes on and the keys for operating the selected component are displayed.

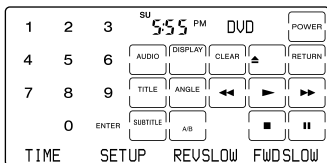

To change the Label keys, press the Mode Display key (in this case, DVD) repeatedly. Each time you press the DVD key, the display of the Label keys changes as follows.

DVD



TIME	SETUP	REVSLOW	FWD	SLOW
		↓		
REPEAT	EDIT	PLAYMODE	DISC	
		↓		
←SEARCH	SEARCH→	DNR	YES	

- 2 Press the desired key in the touch-key display.

When the remote control signal is sent,  is displayed on the display.



If necessary, you can also use buttons on the Commander, such as the VOLUME +/- buttons, the MUTING button or the CHANNEL +/- buttons, other than LCD touch-keys. See "Table of Preset Functions" (page 88) for the functions of keys and buttons for each component.

- 3 When you are done using the Commander, press COMMANDER OFF to turn the Commander off.



Note

The remote control signals may be different for some components or functions. In this case, program the remote control signals with the learning function (see page 19). Note, however, that components and functions that do not support the remote control of infrared signals will not work with this Commander.

To control the volume

Press the VOLUME +/- buttons to control the volume, and the MUTING button to mute. When you select a visual component, the TV's volume will be controlled, and when you select an audio component, the amplifier's volume will be controlled. You can change this setting also (page 29).

Notes

- If you have programmed any signal for the VOLUME +/- buttons or the MUTING button for another component using the learning function (page 19), that signal will be transmitted instead of controlling the volume of the TV or amplifier once you select that component.
- If you have programmed any signal for the VOLUME +/- buttons or the MUTING button of TV or AMP using the learning function, that signal will be also transmitted when you select another component. However, if you have programmed any signal for the VOLUME +/- buttons or the MUTING button of another component, that signal will be transmitted only after you select that component.
- If you have assigned another component to the TV or AMP button, the volume of the TV or amplifier cannot be controlled even when you select other components.

Using Non-Preset Remote Control Operations

— Learning Function

To operate non-preset components or functions, use the following “learning” procedure to “teach” any of the programmable buttons and keys to operate the functions of another remote control. You can also use the learning function to change the signal of individual keys and buttons after setting the component code number (page 12). To “teach” to the Component Select buttons or Label keys, see page 45. To “teach” to the SYSTEM CONTROL buttons or Label keys, see page 49.

Note

Some specific remote control signals may not be learned.

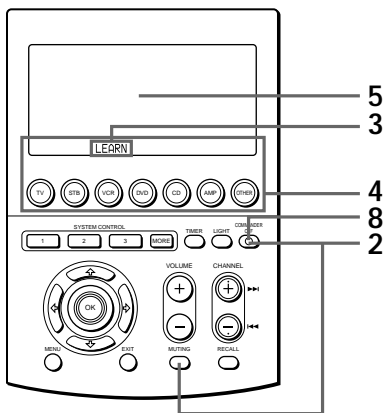

Using Non-Preset Remote Control Operations

— Learning Function (continued)

Example: To program the ► (Play) signal of your component to the VCR ► (Play) key of the Commander

- 1 Place the RM-AV3000 head to head with your component's remote control.

Remote control for your component

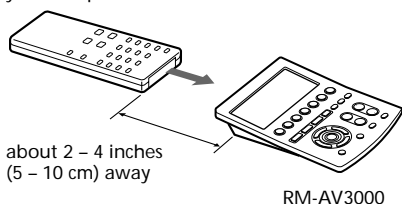

- 2 While pressing COMMANDER OFF, press MUTING.



“SET” appears on the Mode Display key.

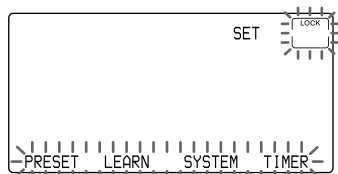

- 3 Press the LEARN key.



“LEARN” appears on the Mode Display key.

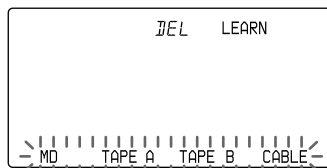

- 4 Select the desired component of which signals are to be learned by pressing the Component Select button or the Label key.



To change the Label keys, press the OTHER button repeatedly. Each time you press the OTHER button, the display of the Label keys changes as follows.

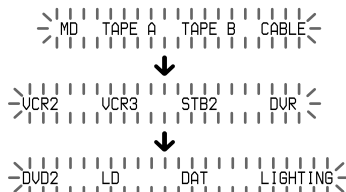

All the learnable keys flash.

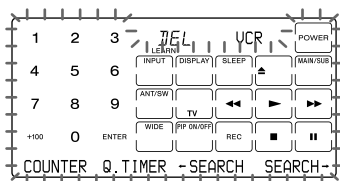

To change the Label keys, press the Mode Display key (in this case, VCR) repeatedly. Each time you press the VCR key, the display of the Label keys changes as follows.

UCR



COUNTER Q. TIMER SEARCH SEARCH



COMMERCL SP/LP H.S. REW PLAY x 2



LINE1 LINE2 DVIn TUTUNER

Note on the flashing display

The keys or buttons that are already preset for that component flash twice while those that are not preset flash once.

To change the name of the Label key

Follow the procedure on page 23.

To change the component name on the Mode Display key

See page 24.

To change the function display of the key

Follow the procedure on page 23.

- 5 Press the key or button on the Commander you want to “teach”.



“LEARN” flashes and the only pressed key remains on the display.



When teaching on the button that is not on the LCD

Only “LEARN” flashes.

- 6 Press and hold down the button on the other remote control until you hear a beep.

(If you release the button before you hear a beep, the signal may not be learned correctly.)



“LEARN” stops flashing and stays lit. When the command has been learned successfully, the learned keys stay lit and the other learnable keys flash.

If “NG” flashes on the display

Learning did not succeed. Try Steps 5 and 6 again.

- 7 Repeat Steps 5 and 6 to teach functions to other keys or buttons.

To learn another component’s remote control signal

Select the component in Step 4, and then follow Steps 5 and 6 to perform learning.

- 8 Press COMMANDER OFF.



If you keep COMMANDER OFF pressed for more than 2 seconds
The Commander turns off.

If you keep COMMANDER OFF pressed for less than 2 seconds
The Commander returns to the previously by set mode.

Using Non-Preset Remote Control Operations

— Learning Function (continued)

Notes

- If you do not perform learning steps within two minutes, learning mode ends.
- If you do not perform Step 6 within 10 seconds after Step 5, the display turns back to the display in Step 4. (All the learnable keys flash.) In this case, perform Step 5 again while the display is flashing.
- If you touch a key by mistake in step 6, while pressing the DEL key, press the mistaken key. Then repeat from Step 5 to continue learning.

If the Commander does not seem to be working

If the learned key or button does not operate properly, teach once again. (For example, if the volume becomes very loud after pressing the VOLUME+ button only once, noise may have interfered during the learning procedure.)

If you set a component code after learning a signal

If you have programmed any signal for a key or button using the learning function, that signal will remain assigned to that key or button even after you set a component code.

When you teach the REC (record) signal

If you have to press two buttons at the same time (for example, ● and ►) to start recording on your cassette deck or VCR, teach the REC signal in one of the following ways.

To operate with two keys on the Commander

In Step 5 (page 21), while pressing the REC key, press the ► key to display both keys. Then press the two buttons on your component's remote control in Step 6.

To operate with one key on the Commander

In Step 5 (page 21), press only the REC key. Then press the two buttons on your component's remote control in Step 6.

When you teach signals to the VOLUME +/- or MUTING buttons

- If you have programmed any signal on the VOLUME +/- or MUTING button for components other than TV and AMP using the learning function, that signal will be transmitted only when you select that component.
- If you have programmed any signal for the VOLUME +/- buttons or the MUTING button of TV or AMP using the learning function, that signal will be also transmitted when you select another component. However, if you have programmed any signal for the VOLUME +/- buttons or the MUTING button of another component, that signal will be transmitted only after you select that component.

When you teach the signals of an air-conditioner

See the notes on page 52.

To display only the frequently used keys

You can hide keys you do not use. After Step 4 on page 20, while pressing the DEL key, press the key you want to hide (flashing). The pressed key changes to slower flashing and will no longer be displayed during remote control operations.

To display it again, perform the same procedure again.

Note

You cannot hide a key which has "learned" any signal.

To change the function display of a key

You can select the most suitable function display among all the displays the key has, and set it to the key.

- 1 After Step 4 (page 20), while pressing the Mode Display key (in this case, VCR), press the key you want to teach repeatedly.

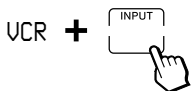

Each time the key is pressed, the display is changed in order.

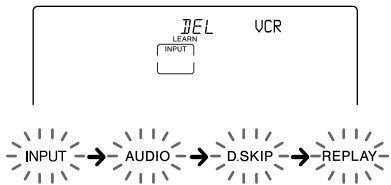

- 2 When the desired display appears, release the Mode Display key.



- 3 Then follow Steps 6 to 8 (page 21).

Notes

- You can change the display of a key only when you program it using the learning function. If you want to change the display of the key that has learned a signal, clear the signal first (page 25). Then teach the key again using the above procedure to change its display.
- If you don't change the display of a key, the default display is used.
- You cannot change the display of the area of the numeric keys 1 to 9.

To change the name of the Label key

You can change the display of the Label key to the most suitable name using up to 8 characters or digits.

- 1 After Step 4 (page 20), hold the Label key of which name you want to change (for example, COUNTER) pressed for more than 2 seconds.

COUNTER



The Commander enters the Label Input mode.

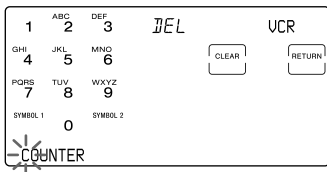

Using Non-Preset Remote Control Operations

— Learning Function (continued)

-
- 2** Input digits or characters on the Label key by pressing the number keys (0 - 9), SYMBOL 1 key or SYMBOL 2 key on the LCD display.

The cursor flashes in the left end of the Label key.

Begin inputting digits or characters from the left. Press repeatedly the number key until you obtain the desired digit or character.

The digits or characters are assigned to the keys as follows.

1: 1

2: A → B → C → a → b → c → 2

3: D → E → F → d → e → f → 3

4: G → H → I → g → h → i → 4

5: J → K → L → j → k → l → 5

6: M → N → O → m → n → o → 6





7: P → Q → R → S → p → q → r →
s → 7

8: T → U → V → t → u → v → 8

9: W → X → Y → Z → w → x → y
→ z → 9

0: 0

SYMBOL 1 : !, &, /, ?, →, ←, ↑, ↓, +, -, :,
, ., ", ', ~, *, #, |, space

SYMBOL 2 : space, , , , , ,
(,), <, >, ◀, ▶, ◀◀, ▶▶, ■,
○, ■, ×, \$

If you make a mistake, move the cursor to the digit or character you want to correct by pressing the ⇐ or ⇒ button, and input again.

If you press the CLEAR key, the Label key returns to the previous display.

-
- 3** Decide the digit or the character you input by pressing the ⇐ button or another number key.

The cursor moves to the right.

When the ⇐ button is pressed, the cursor moves to the left. You can input a digit or character to the place where the cursor flashes.

-
- 4** Repeat Steps 2 and 3 until you input a suitable name to the Label key.

When the cursor reaches to the right end, if the ⇐ button or another number key is pressed, the cursor returns back to the left end.

-
- 5** Decide the display of the Label key by pressing the RETURN key. The LCD display goes to Step 5 on page 21.
-

For accurate learning

- Do not move the remote units during the learning procedure.
- Be sure to keep holding down the button of the other remote control until you hear the confirmation beep.
- Use fresh batteries in both remote control units.
- Avoid learning in places under direct sunlight or strong fluorescent light.
- The remote control detector area may differ depending on each remote unit. If learning does not work, try changing the positions of the two remote control units.
- When you teach signals of an interactive signal exchange system remote control unit (supplied with some of Sony's receivers and amplifiers) to the Commander, the response signal of the main unit may interfere with the learning of the Commander. In such a case, move to a place where the signals will not reach the main unit (e.g. other rooms, etc.).

IMPORTANT

Be sure to place the Commander out of the reach of small children or pets. Also set the Hold function to lock the all buttons on the Commander (page 71) when it is not used. Components such as air conditioners, heaters, electric appliances, and electric shutters or curtains receiving an infrared signal can be dangerous if misused.

Changing or erasing the function of a taught key or button

To change the learned function, clear it first and perform learning again.

To clear the learned function of a single key or button

- 1 After Step 4 (page 20), while pressing the DEL key, press the key or button you want to erase.

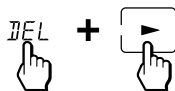

The cleared key flashes together with other learnable keys.

- 2 Press COMMANDER OFF.



If you keep COMMANDER OFF pressed for more than 2 seconds
The Commander turns off.

If you keep COMMANDER OFF pressed for less than 2 seconds
The Commander returns to the previously set mode.

Using Non-Preset Remote Control Operations

— Learning Function (continued)

To clear all signals learned for a specific component

- 1 While pressing COMMANDER OFF, press MUTING.



“SET” appears on the Mode Display key.

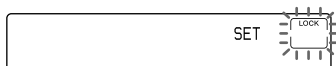

- 2 Press the Mode Display key (SET) once

SET



“RESET” appears and flashes on one of the Label keys on the display.

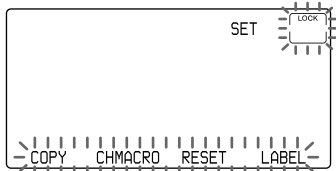

- 3 Press the RESET key.



“RESET” appears on the Mode Display key.

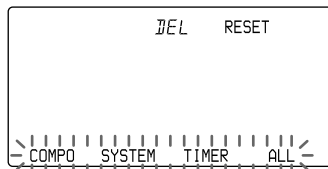

- 4 Press the COMPO key



Component names appear on the Label keys.

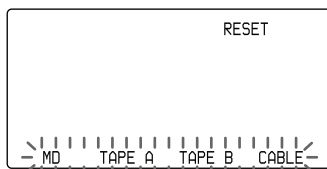

To change the Label keys, press the OTHER button repeatedly. Each time you press the OTHER button, the display of the Label keys changes as in Step 4 on page 13.

- 5** Press the Component Select button or the Label key of which preset settings you want to erase. The component name is displayed on the left Label key.

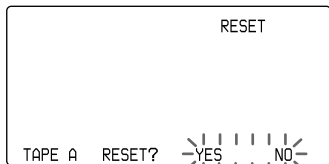

- 6** Press the YES key.



During erasing, "→ →" stays lit. When erasing finishes, "OK" is displayed with a beep sound.

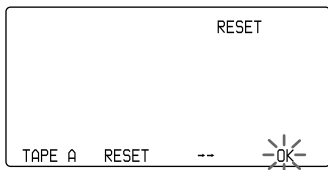

If you press the NO key
The display returns to Step 4.

If you want to erase the learned signals for other Component Select buttons or corresponding Label keys
Repeat Steps 5 - 6.

- 7** Press COMMANDER OFF.



If you keep COMMANDER OFF pressed for more than 2 seconds
The Commander turns off.

If you keep COMMANDER OFF pressed for less than 2 seconds
The Commander returns to the previously set mode.

To clear all signals learned for all Component Select buttons or corresponding Label keys

- 1** Follow Steps 1 - 3 on page 26.

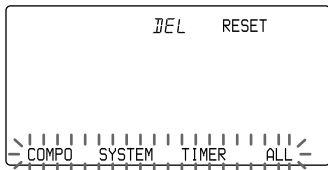

- 2** While pressing the DEL key, press the COMPO key.

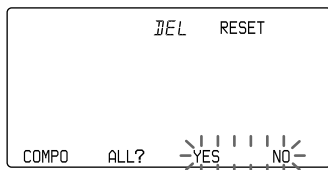
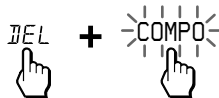

Using Non-Preset Remote Control Operations

— Learning Function (continued)

- 3 Press the YES key.



“REALLY?” stays lit. “YES” and “NO” flash.

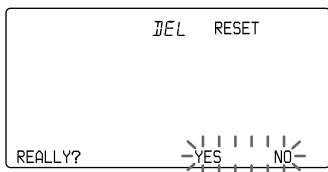

If you press the NO key

The display returns to Step 1.

- 4 Press the YES key.



While erasing, “→ → → →” stays lit.
When all settings programmed for the Component Select buttons and corresponding Label keys are erased, “OK” is displayed with a beep sound.

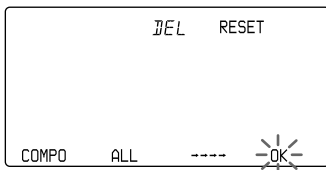

If you press the NO key

The display returns to Step 1.

- 5 Press COMMANDER OFF.



If you keep COMMANDER OFF pressed for more than 2 seconds
The Commander turns off.

If you keep COMMANDER OFF pressed for less than 2 seconds
The Commander returns to the previous setting mode.

Controlling the Volume of Visual Components Connected to an Audio System

The Commander is factory preset based on the assumption that you hear the sound of your visual components from your TV speakers, and that you hear sound of your audio components from the loudspeakers connected to your amplifier.

This feature enables you to control the volume of your TV or amplifier without having to select TV or AMP each time you want to control the volume. For example, to control the volume while using a VCR, you don't need to press the TV button to control the TV volume. You can switch the volume of all the visual components to the amplifier at the same time.

The following table shows the factory setting of which volume would be controlled for each component.

Component Select button	Controls the volume of
TV	TV
STB	TV
VCR	TV
DVD	TV
CD	amplifier
AMP	amplifier

Label key	Controls the volume of
MD	amplifier
TAPE A	amplifier
TAPE B	amplifier
CABLE	TV
VCR2	TV
VCR3	TV
STB2	TV
DVR	TV
DVD2	TV
LD	TV
DAT	amplifier
LIGHTING	-----

However, if your visual components are connected to an audio system, you probably hear TV or VCR sound from the loudspeakers via your amplifier, not from your TV speakers. In this case, you need to change the factory preset so that you can control the volume of your visual components without first having to switch to the amplifier.

To change the Factory Preset of the Volume Control

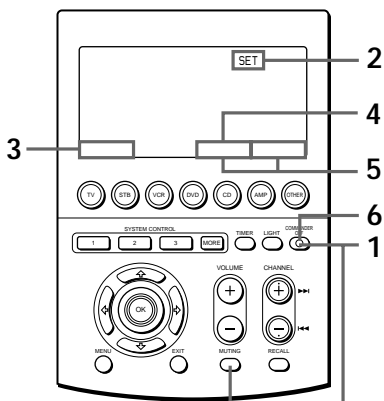

Controlling the Volume of Visual Components Connected to an Audio System (continued)

- 1 While pressing COMMANDER OFF, press MUTING.



“SET” appears on the Mode Display key.

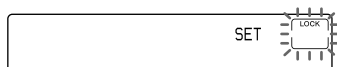

- 2 Press the Mode Display key (SET) twice.



Each time the SET key is pressed, the Label keys changes as in Step 2 on page 13.

“MODE” appears and flashes on one of the Label keys.

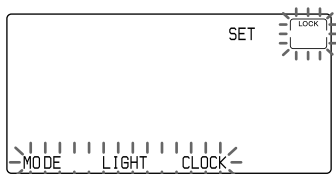

- 3 Press the MODE key.



“MODE” appears on the Mode Display key.

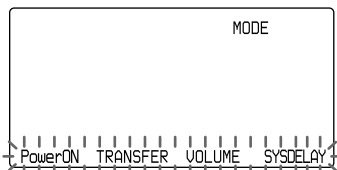

- 4 Press the VOLUME key.



“VOLUME” appears on the Mode Display key, and “AMP” flashes on one of the Label keys.

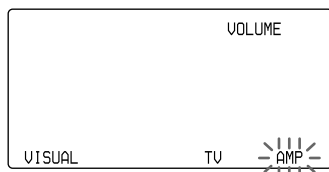

- 5 To change the volume control setting of visual components (TV, STB, STB2, DVR, VCR, VCR2, VCR3, DVD, DVD2, LD and CABLE) press the AMP key. With a beep sound, the volume control setting of visual components is switched to the amplifier.

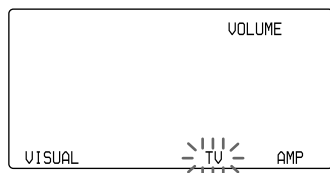

To return the volume control setting to "TV", press the TV key.

-
- 6** Hold **COMMANDER OFF** pressed for more than 2 seconds to turn the Commander off.

If you keep **COMMANDER OFF** pressed for less than 2 seconds, the display returns to the previous setting mode.



Notes

- If you have already programmed any signal for the **VOLUME** or **MUTING** button of each component by "learning", the procedure above will not change the function of the **VOLUME** and **MUTING** buttons.
- If you have programmed volume control signals on **VOLUME** or **MUTING** buttons of TV or AMP, you can only use that signal when you select TV or AMP. For other component, the preset volume control signals for TV or AMP (depending on the above setting procedure) will be transmitted. To use the new signals, you need to program each button for each component by the learning procedure (page 20).

Executing a Series of Commands

— System Control Functions

With the System Control function, you can program a series of operating commands, and execute them by pressing just one button.

For example, when you watch a video, a series of operations like the ones below are necessary.

Example:

- 1 Turn on the TV.
- 2 Turn on the video (VCR).
- 3 Turn on the amplifier.
- 4 Set the input selector of the amplifier to VIDEO 1.
- 5 Set the input mode of the TV to VIDEO 1.
- 6 Start video playback

You can program up to 32 consecutive operation steps to each of the **SYSTEM CONTROL** buttons (1-3) or the Label keys (**SYSTEM** 4-15).

If you have set the System Control function for a Component Select button or a Label key (page 38), the execution of the programmed commands begins when you press the Component Select button for more than 2 seconds.

The component macro executing time is variable by changing the setting (page 42). While executing the programmed commands, at the same time that each remote control signal is transmitted, the corresponding key is displayed.

Preset programs for the **SYSTEM CONTROL 1** and **3** buttons

The **SYSTEM CONTROL 1** and **3** buttons are preset at the factory to execute each program as follows.

SYSTEM CONTROL 1 button:

Turn off all the Sony components that could receive the signal from the Commander at the same time.

SYSTEM CONTROL 2 button:

Turn on all the Sony components that could receive the signal from the Commander at the same time.

Executing a Series of Commands
— System Control Functions
(continued)

Programming a series of commands for the SYSTEM CONTROL buttons or the Label keys

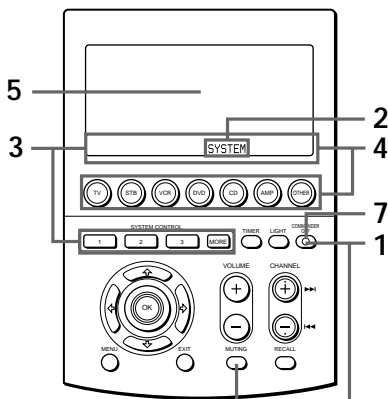

Example: To program the procedure above for the SYSTEM CONTROL 2 button

- 1 While pressing COMMANDER OFF, press MUTING.



"SET" appears on the Mode Display key.

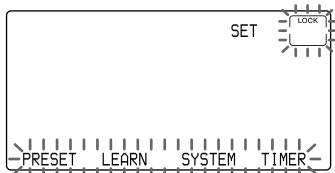

- 2 Press the SYSTEM key.



"SYSTEM" appears on the Mode Display key.

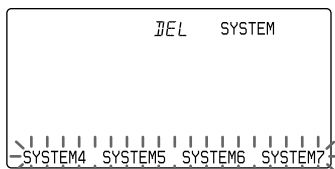

- 3 Select the system number by pressing the SYSTEM CONTROL button (in this case, SYSTEM CONTROL 2) or the Label key.

To change label keys, press the MORE button repeatedly until you obtain the desired system number.

Each time you press the MORE button, the display of the Label keys changes as follows.

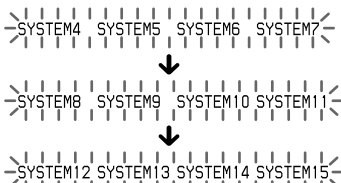

The selected system number is displayed on the Mode Display key.

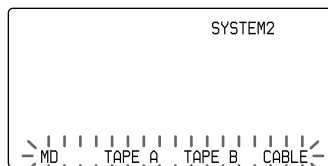

To program a new series of operations for the buttons which have already been set

SYSTEM CONTROL 1 or 3 button:

Erase the factory preset program. See page 37.

Other buttons:

Erase the program. See page 35.

- 4 Select the component to operate by pressing the Component Select button (in this case, TV) or the Label key.

To change label keys, press the OTHER button repeatedly until you obtain the desired component name.



The selected component name is displayed on the Mode Display key, and the keys for the selected component flash.

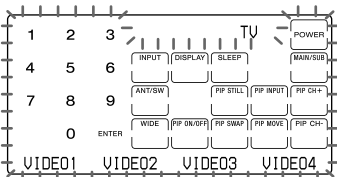

- 5 Press the key(s) or button(s) for the desired operation.



If you want to turn on the TV, press the POWER key.

- 6 Repeat Steps 4 and 5 and program the buttons and keys for the series of operations.

In this example, press the following buttons and keys.

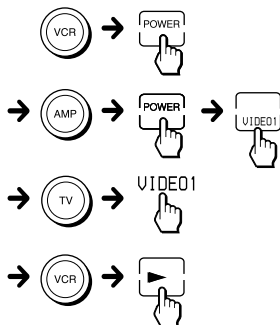

- 7 When you have programmed all the keys and buttons, press COMMANDER OFF.



With a beep sound, a series of operating commands is registered and displayed in order. When the display of keys for the component of which key you programmed last appears, the System Control setting finishes.

If you keep COMMANDER OFF pressed for more than 2 seconds
The Commander turns off.

When you have programmed the buttons on the Commander
The names of buttons on the Commander which are not on the LCD touch key display (VOLUME +/-, MUTING, CHANNEL +/-, RECALL, MENU, OK, EXIT, ⏪, ⏩, ⏴, ⏵, and ⏶) are displayed on the right Label key.

Executing a Series of Commands — System Control Functions (continued)

Notes

- If you interrupt the procedure at any point for over two minutes, the setting mode ends and the series of commands will be programmed to that point. In this case, clear the program (page 35) and start again from Step 1 to set the entire program from the beginning. You cannot continue from where you let off.
- If a SYSTEM CONTROL button or a Label key has already “learned” a remote control signal (page 49), “NG” flashes and you cannot program on this button. Clear the learned contents first (page 51).
- If you change the component code number (page 12) or program a new signal by learning (page 19) on a key or button that has been programmed in the series of commands of the System Control function, the new signal will be transmitted when you press the corresponding SYSTEM CONTROL button or a Label key.
- During programming of a series of operating commands, the DEL key is not displayed and you cannot clear any operation step you have programmed. If you have programmed an incorrect operation by mistake, start again from Step 1.
- If you try to program more than 32 steps, the System Control setting finishes, and the 32 steps you have programmed are registered. If you want to program again, clear the program (page 35) and start again from Step 1.
- When programming a power-on command for the System Control function, if you select the Component Select button or the Label key for which you programmed the Power-on setting (page 43), the Power-on setting is also available. So, the power of the selected component turns off if the POWER key of the component is programmed. In this case, clear the Power-on setting, or do not program the POWER key of the component.

About the interval between operation steps

- You can change the interval between operation steps (page 40).
- If you cannot receive signals successfully during consecutive operation steps, program the interval between steps by pressing the TIMER button between operation steps in Step 6 on page 33. This operation of programming an interval is counted also as a step.

To change the display of the component name on the Mode Display key

When you program a series of operating commands, you can change the display of the component name to the most suitable name using up to 8 characters or digits.

After Step 3 (page 32), hold the Mode Display key pressed for more than 2 seconds. Then follow the same procedure as that for changing the name of the Label key in “To change the display of the Label key”, Steps 2 - 5 on page 24. If you press the CLEAR key, the Label key returns to the previous display.

About the order of operation steps

- Some of the components may not accept consecutive remote control signals. For example, a TV generally does not react to next signal right after the Power-on signal. So, a series of commands such as TV Power-on and input select may not work properly. In this case, insert other signals like the example below:
TV Power-on → VCR Power-on
→ VCR play back → TV input select
- After the series of input commands is executed, the Commander displays the touch-keys of the component in the final step. By programming an often-used component's command as the final step, you can save the step of pressing a Component Select button or a Label key when you start operating that component. (In the example on page 33, the touch-keys of TV are displayed.)
- If a series of commands is programmed for the Component Select button or the Label keys (page 38), the display of that component is shown after the program is executed.

To clear programmed commands for a specific SYSTEM CONTROL button or corresponding Label key

- 1** While pressing COMMANDER OFF, press MUTING.



“SET” appears on the Mode Display key.

- 2** Press the Mode Display key (SET) once to display “RESET” on one of the Label keys on the display.

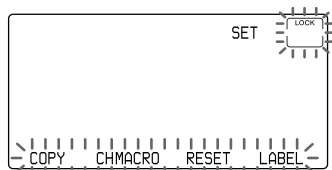

- 3** Press the RESET key.



“RESET” appears on the Mode Display key.

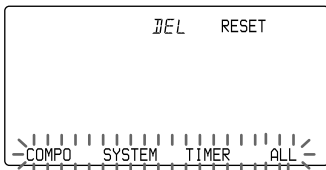

- 4** Press the SYSTEM key.



System numbers appear on the Label keys.

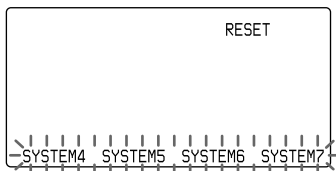

To change Label keys, press the MORE button repeatedly until you obtain the desired system number. Each time you press the MORE button, the display of the Label keys changes as in Step 3 on page 32.

- 5** Press the SYSTEM CONTROL button (1, 2 or 3) or the Label key (SYSTEM4 - SYSTEM15) of which programmed commands you want to erase.

The selected system number is displayed on the left Label key.

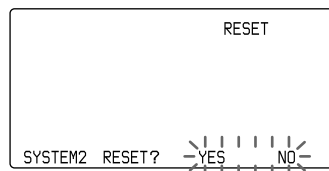

- 6** Press the YES key.



Executing a Series of Commands — System Control Functions (continued)

If you press the NO key

The display returns to Step 4.

While erasing, “→ →” stays lit. When erasing finishes, “OK” is displayed with a beep sound.

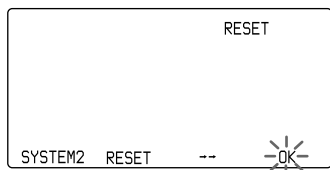

7 Press COMMANDER OFF.

COMMANDER
OFF



If you keep COMMANDER OFF pressed for more than 2 seconds

The Commander turns off.

If you keep COMMANDER OFF pressed for less than 2 seconds

The Commander returns to the
previous setting mode.

To erase all programmed
commands for all SYSTEM
CONTROL buttons and
corresponding Label keys

1 Follow Steps 1 - 3 in the left.

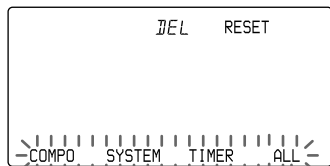

2 While pressing the DEL key, press the SYSTEM key.

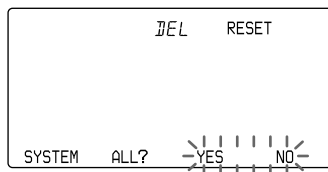
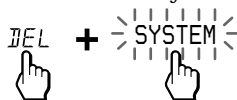

3 Press the YES key.



“REALLY?” stays lit, and “YES” and
“NO” flash.

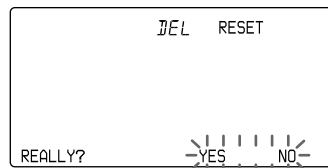

If you press the NO key

The display returns to Step 1.

4 Press the YES key.



While erasing, “→ → → →” stays lit.
When all settings programmed for the
Component Select buttons and
corresponding Label keys are erased,
“OK” is displayed with a beep sound.

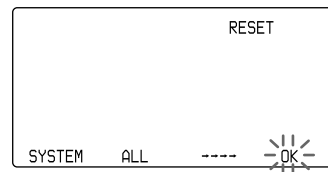

If you press the NO key

The display returns to Step 1.

5 Press COMMANDER OFF.

COMMANDER
OFF



If you keep COMMANDER OFF pressed for more than 2 seconds

The Commander turns off.

If you keep COMMANDER OFF pressed for less than 2 seconds

The Commander returns to the previous setting mode.

To erase the SYSTEM CONTROL 1 or 3 button

At the factory, the SYSTEM CONTROL 1 button is preset with a series of power-off commands for Sony components and the SYSTEM CONTROL 3 button with a series of power-on commands for Sony components.

To erase the programmed commands for each button, follow the steps below.

- 1 While pressing COMMANDER OFF, press MUTING.
- 2 Press the SYSTEM key on the display.
- 3 While pressing the DEL key, press the SYSTEM CONTROL 1 or 3 button. The program for the selected button is erased.

To set the SYSTEM CONTROL 1 or 3 button back to the factory setting

To reset them to the factory settings, follow the steps below.

- 1 Clear the “learned” function (See “To clear the learned function of a single key or button,” page 25.) or the System Control function (See “To clear programmed commands for a specific SYSTEM CONTROL button or corresponding Label key,” page 35.) programmed on SYSTEM CONTROL 1 or 3.

- 2 Clear again the System Control function programmed on SYSTEM CONTROL 1 or 3 (page 35). Select SYSTEM CONTROL 1 or 3, in Step 5 on page 35.

Note

The interval setting (page 40) is not reset to the factory setting, even if you perform these steps.

Notes on System Control Operations

- If the remote control detectors of the components are too far apart, or if something is blocking them, some of the components may not operate consecutively even after you press the SYSTEM CONTROL button or a Label key.
- If some of the components did not operate correctly because of the above or for any other reason, always set all the components back to the states they were in before you pressed the SYSTEM CONTROL button or a Label key. Failure to do this can result in incorrect operation when you press the SYSTEM CONTROL button or a Label key again.
- Some components may not always be powered on by the System Control function. This is because the power of the component goes on and off alternatively when receiving the power on/off signal. In this case, check the operating component’s power on/off state before using the system control function.

Programming a series of commands for the Component Select buttons or the Label keys

As with the SYSTEM CONTROL buttons or the Label keys, you can also program a series of operating commands for the Component Select buttons (up to 32 steps). To execute the commands programmed on a Component Select button or a Label key by the System Control function, press the button or key for more than 2 seconds. The component macro executing time is variable by changing the setting (page 42).

Notes

- The programmed commands are executed when you press a Component Select button or a Label key for more than 2 seconds. When you press the button or the Label key for less than 2 seconds, it works as the normal Component Select button or key, and the corresponding touch-keys are displayed.
- See also “About the interval between operation steps” on page 34 and “Notes on System Control Operations” on page 37.

Example: To program the procedure on page 31 for the TV button

1 Follow Steps 1 and 2 on page 32.

If a series of commands is already programmed for that button

The programmed operations are displayed in order. To program a new series of operations, clear the program first (page 39).

2 Press the Component Select button for which you want to program a series of commands.



The selected component name appears on the Mode Display key. Other component names are displayed on the Label keys.

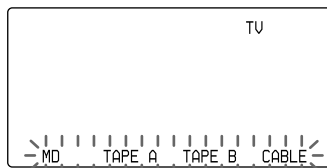

You can select the Label key for programming a series of commands by pressing the desired Label key. To change the component names of the Label keys, press the OTHER button repeatedly. Each time you press the OTHER button, the display of the Label keys changes as in Step 4 on page 13.

3 Follow Steps 4 to 7 on pages 33.

Notes

- You can program the System Control functions for a Component Select button or a Label key on which the Power-On function (page 43) has been programmed. In this case, the Power-On function is overwritten and cannot be used. If you clear the System Control functions for the button, the Power-On function is resumed, and you can use it again.
- You cannot program the System Control functions for a Component Select button or a Label key for which a signal has been programmed by "learning" (page 45). ("NG" flashes on the display.)
- You can program the Power-On function (page 43) for a Component Select button or a Label key for which a System Control function has been programmed, but the Power-On function cannot be used. If you clear the System Control function from the button, you can use the Power-On function.
- If you interrupt the procedure at any point for over two minutes, the setting mode ends and the series of commands will be programmed to that point. In this case, clear the program and start again from Step 1 to set the entire program from the beginning. You cannot continue from where you let off.
- If you change the component code number (page 12) or program a new signal by learning (page 19) for a key or button that has been programmed with the series of commands of a System Control function, the new signal will be transmitted when you press the corresponding Component Select button or a Label key.

To clear a System Control function programmed for Component Select buttons and Label keys

1 Follow Steps 1-4 on page 26.

2 While pressing the DEL key, press the Component Select button (or Label key) of the System Control function you want to clear.

To change the Label keys, press the OTHER button repeatedly.

3 Press COMMANDER OFF.

COMMANDER
OFF



If you keep COMMANDER OFF pressed for more than 2 seconds
The Commander turns off.

If you keep COMMANDER OFF pressed for less than 2 seconds
The Commander returns to the previous setting mode.

**Executing a Series of Commands
— System Control Functions
(continued)**

**Changing the interval
between operation steps**

You can control the interval from 100-900ms in units of 50ms.

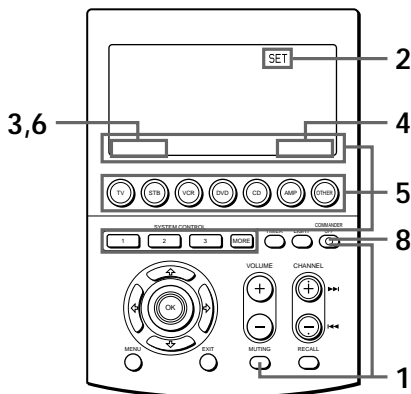

- 1** While pressing COMMANDER OFF, press MUTING.

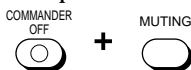

“SET” appears on the Mode Display key.

- 2** Press the Mode Display key (SET) twice to display “MODE” on one of the Label keys on the display.

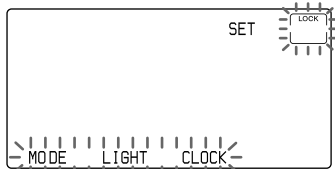

- 3** Press the MODE key.
“MODE” appears on the Mode Display key.

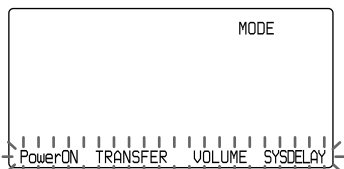

- 4** Press the SYSDELAY key.



“SYSDELAY” is displayed on the Mode Display key.

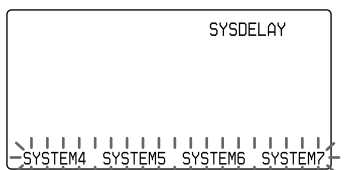

- 5** Select the system number, the component name or the timer program number of the interval you want to change by pressing the SYSTEM CONTROL button, the Component Select button or the Label key.

To change the Label keys for system numbers

Press the MORE button repeatedly.

To display and change the Label keys for component names

Press the OTHER button repeatedly.

To display and change the Label keys for timer program numbers

Press the TIMER button repeatedly. For timer settings, see page 61.

When you select the Component name, go to Step 6.

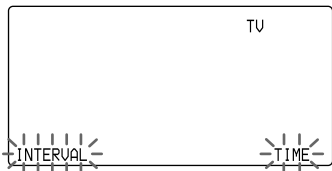

When you select the system number or the timer program number, go to Step 7.

6 Press the INTERVAL key.

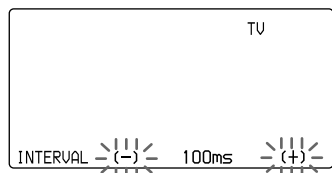

The current interval setting stays lit, and (+) and (-) flash.

7 Press the (+) or (-) key to change the interval. You can control the interval from 100 to 900ms in units of 50ms.

Each time you the (+) key is pressed, the interval increases by 50 ms.

Each time you the (-) key is pressed, the interval decreased by 50 ms.

(ms: 1/1000 second)

8 Press COMMANDER OFF.

COMMANDER

OFF



If you keep COMMANDER OFF pressed for more than 2 seconds
The Commander turns off.

If you keep COMMANDER OFF pressed for less than 2 seconds
The Commander returns to the previous setting mode.

**Executing a Series of Commands
— System Control Functions
(continued)**

**To change the component
macro executing time**

1 Follow the procedure of Steps 1 - 5 on page 40.

2 Press the TIME key.

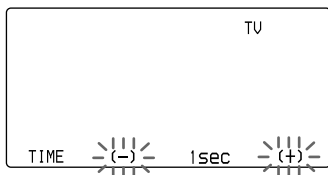

The current component macro executing time stays lit, and (+) and (-) flash.

3 Press the (+) or (-) key to change the component macro executing time. You can control the time from 0 to 2 sec (seconds) in units of 1 sec.

Each time you the (+) key is pressed, the time increased by 1 sec.

Each time you the (-) key is pressed, the time decreases by 1 sec.

4 Press COMMANDER OFF.

COMMANDER

OFF



If you keep COMMANDER OFF pressed for more than 2 seconds
The Commander turns off.

If you keep COMMANDER OFF pressed for less than 2 seconds
The Commander returns to the previous setting mode.

Adding an Extra Function to the Component Select Buttons

Programming the Power-On command of the selected component (for Sony components only)

When using Sony components, you can program the Power-on signal for each component on a Component Select button or a Label key. You can select the desired component and turn it on by just pressing that Component Select button or a Label key.

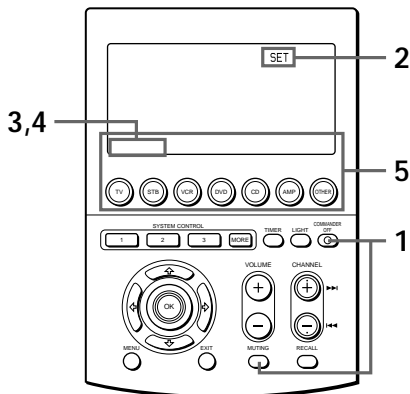

Example: To program the TV button

- 1 While pressing COMMANDER OFF, press MUTING.



“SET” appears on the Mode Display key.

- 2 Press the Mode Display key (SET) twice to display “MODE” on one of the Label keys on the display.

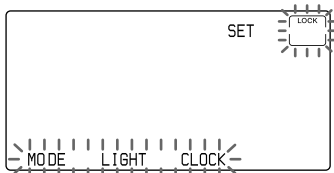

- 3 Press the MODE key. “MODE” appears on the Mode Display key.

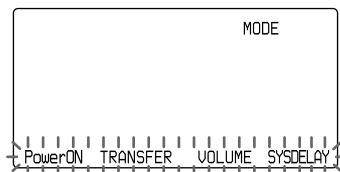

Adding an Extra Function to the Component Select Buttons (continued)

4 Press the PowerON key.



“PowerON” appears on the Mode Display key.

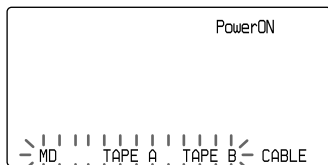

The display of the component names (preset by Sony) for which you can program the Power-on signal flashes. The display of the other components stays lit.

5 Select the desired component by pressing the Component Select button or the Label key. (To change the Label keys, press the OTHER button repeatedly.)



The selected component name appears on the Mode display key and “POWER ON” appears on the display with a beep sound.

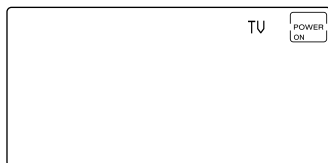

To clear the Power-on command

Repeat the procedure above.
The following display appears.



6 Press COMMANDER OFF.

COMMANDER
OFF



If you keep COMMANDER OFF pressed for more than 2 seconds
The Commander turns off.

If you keep COMMANDER OFF pressed for less than 2 seconds
The Commander returns to the previous setting mode.

Notes

- If the component code of a non-Sony product has been set for a Component Select button or a Label key, you cannot program the Power-On function for it.
- Even if you have programmed a signal by “learning” (See “Adding a command that is required when selecting a component”, page 45) or a System Control function (page 38) for a Component Select button or a Label key, you can program the Power-On function for that button, but it cannot be used. If you clear a “learned” signal or the System Control function from the button or key, you can use the Power-On function.
- You can program a signal by “learning” (page 45) or a System Control function (page 38) for a Component Select button for which the Power-On function has been programmed. In this case, the Power-On function is overwritten and cannot be used. If you clear the “learned” signal or the System Control function from the button or key, the Power-On function is resumed, and you can use it again.
- You can set the learning function (page 46) or the System Control function (page 31) to the Component Select button or the Label key for which you programmed the Power-on signal. In this case, the Power-on setting is also available and the Power-on signal is output. So check the setting of Power-on signal before setting the learning function or the System Control function.

Adding a command that is required when selecting a component

In addition to the original function of selecting the operating keys and buttons of the desired component, the Component Select button or the Label key can have another remote control signal by “learning.”

For example, if you always have to change input select of the amplifier to CD when listening to the CD player, program the signal of “changing the amplifier’s input select” to the CD button of this Commander. Then whenever you press the CD button, it automatically works as the original CD Component Select button and changes also the amplifier input select to CD. (In this case, the amplifier should be turned on first.)

Note

Some specific remote control signals may not be learned.

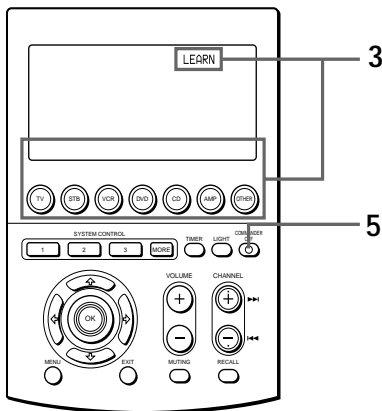

Adding an Extra Function to the Component Select Buttons (continued)

Example : To program the input select signal of your amplifier to the CD button

- 1 Place the RM-AV3000 head to head with your component's remote control.

Remote control of your component

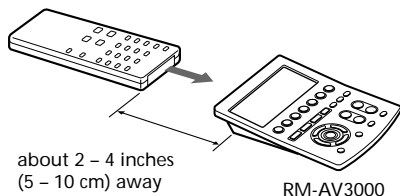

- 2 Follow Steps 2 and 3 on page 20 in "Learning Function".

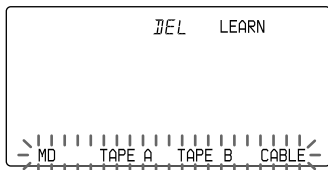

- 3 While pressing the Mode Display key (LEARN), press the Component Select button or the Label key you want to "teach," and release both keys.
(To change the Label keys, press the OTHER button repeatedly.)
The selected component name appears on the Mode Display key, and "LEARN" begins to flash.

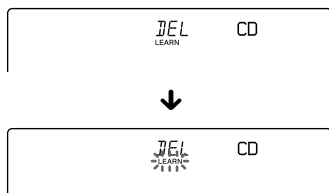

- 4 Press and hold down the button on the component's remote control (amplifier in this example) until you hear a beep.
(If you release the button before you hear a beep, the signal may not be learned correctly.)

INPUT SELECT
CD



"LEARN" stops flashing and stays lit.

If "NG" flashes on the display
Learning did not succeed. Try Steps 3 and 4 again.

- 5 Press COMMANDER OFF.



If you keep COMMANDER OFF pressed for more than 2 seconds

The Commander turns off.

If you keep COMMANDER OFF pressed for less than 2 seconds

The Commander returns to the previously set mode.

To clear the learned function of the Component Select button

- 1 Follow Steps 2 and 3 on page 20 in "Learning Function."
- 2 While pressing the DEL key, press the Component Select button which you want to clear.

Notes

- You can program a signal by "learning" for a Component Select button or a Label key for which the Power-On function (page 43) has been programmed. In this case, the Power-On function is overwritten and cannot be used. If you clear the "learned" signal from the button, the Power-On function is resumed, and you can use it again.
- You cannot program a System Control function (page 38) for a Component Select button or a Label key for which a signal has been programmed by "learning."
- You can program the Power-On function for a Component Select button for which a signal has been programmed by "learning," but then the Power-On function cannot be used. If you clear a "learned" signal from the button, you can use the Power-On function.

Assigning Other Components to the Component Select Buttons or the Label Keys

Copying the settings of a Component Select button or a Label key to another button or key

You can copy the entire settings of a Component Select button or a Label key to another Component Select button or a Label key. The settings of the component code (page 12), the channel macro function (page 58), the learned functions (page 19) and character contents are copied to a new button or key.

Notes

- You cannot copy the settings to a Component Select button or a Label key for which any learning function or channel macro function has been programmed. ("NG" flashes.)
- The character contents are overwritten to a new button or key.

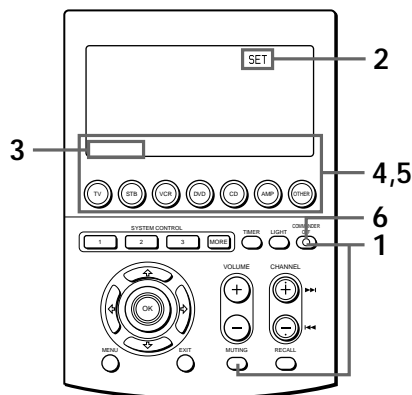

Assigning Other Components to the Component Select Buttons or the Label Keys (continued)

Example: To copy the settings of the DVD button to the VCR button

- 1 While pressing COMMANDER OFF, press MUTING.



“SET” appears on the Mode Display key.

- 2 Press the Mode Display key (SET) once to display “COPY” on one of the Label keys on the display.

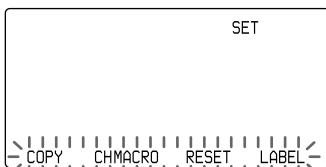

- 3 Press the COPY key.



“COPY” appears on the Mode Display key.

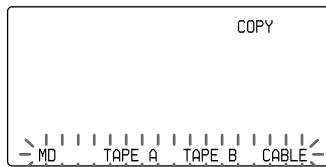

- 4 Press the Component Select button or the Label button of which contents are to be moved. (To change the Label buttons press the OTHER button.)

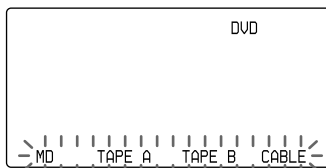

The component name of which contents are to be moved appears on the Mode Display key.

- 5 While pressing the Mode Display key (in this case, DVD), press the Component Select button or the Label key to which the contents are to be moved (in this case, VCR).

(To change the Label keys, press the OTHER button.)

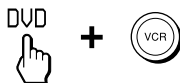

“COPY” appears on the Mode Display key.

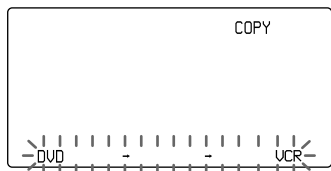

In this case, “DVD → → VCR” flashes on the Label keys and moving finishes with a beep sound. And the keys for VCR appears.

6 Press COMMANDER OFF.



If you keep COMMANDER OFF pressed for more than 2 seconds
The Commander turns off.

If you keep COMMANDER OFF pressed for less than 2 seconds
The Commander returns to the previous setting mode.

To return to the original setting

Follow steps in “To clear all signals learned for a specific component”, page 26.

Programming a Frequently Used Key Operation for SYSTEM CONTROL Buttons or Label Keys

In addition to their original System Control functions (see page 31), SYSTEM CONTROL 1, 2 or 3 buttons or SYSTEM 4 - 15 Label keys can be programmed to “learn” any remote control signal.

As they operate independently from other buttons, SYSTEM CONTROL 1, 2 or 3 buttons can work as one-touch buttons without any preceding operation such as pressing a Component Select button to select a component.

This is useful if you prefer having the SYSTEM CONTROL button as a “one-touch” button for a single operation rather than executing a series of commands.

Note

Some specific remote control signals may not be learned. Refer to the operating instructions supplied to the specific remote control as well.

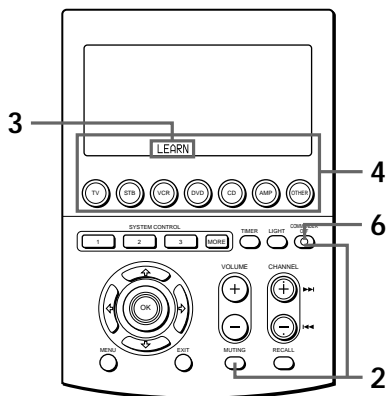

Programming a Frequently Used Key Operation for SYSTEM CONTROL Buttons or Label Keys
(continued)

Example: To store the On/Off signal of an air-conditioner to the SYSTEM CONTROL 2 button

1 Place the Commander head to head with the remote control of the air-conditioner.

Remote control of your air-conditioner

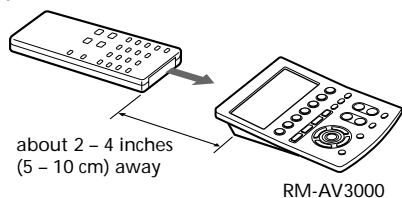

2 While pressing COMMANDER OFF, press MUTING.



“SET” appears on the Mode Display key.

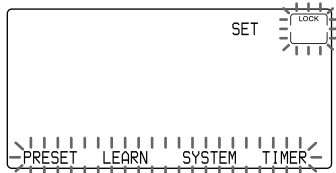

3 Press the LEARN key.



“LEARN” appears on the Mode Display key.

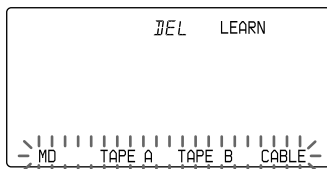

If a signal has been learned on that button, the display stays lit. If you want to program on that button, clear the signal first (page 51).

4 Press the SYSTEM CONTROL button (in this case, 2).

Or press the MORE button to display the SYSTEM (4-15) Label keys. To change the Label keys press the MORE button repeatedly. Then press the Label key you want to teach.



The display for the pressed SYSTEM CONTROL button or Label key appears on the Mode Display key. “LEARN” flashes for 10 seconds, and the Commander enters receiving mode.

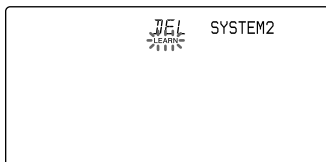

-
- 5** Press and hold down the button of the remote control until you hear a beep.

(If you release the button before you hear a beep, the signal may not be learned correctly.)

AIR CONDITIONER



While receiving the signal, “LEARN” stays lit.

If “NG” flashes on the display and “NG” sound is heard five times

Learning did not succeed. Try Steps 4 and 5 again.

-
- 6** Press COMMANDER OFF.

COMMANDER

OFF



Note

You cannot program a remote control signal for a SYSTEM CONTROL button or a Label key by “learning” for which the System Control function have been programmed. If you want to program a remote control signal for that button, clear programmed commands first (page 35).

To clear the learned remote control signal

- 1 While pressing COMMANDER OFF, press MUTING.
- 2 Press the LEARN key. “LEARN” appears on the Mode Display key.
- 3 While pressing the DEL key, press the SYSTEM CONTROL button or the Label key of which learned signals are to be cleared. The learned signals are cleared.
- 4 Press COMMANDER OFF.

If you want to program a new signal for that button, follow Steps 4 to 6 in the left column.

If you keep COMMANDER OFF pressed for more than 2 seconds
The Commander turns off.

If you keep COMMANDER OFF pressed for less than 2 seconds
The Commander returns to the previous setting mode.

Programming a Frequently Used Key Operation for SYSTEM CONTROL Buttons or Label Keys (continued)

Notes on learning the signals of an air-conditioner

About seasonal adjustments

If you change the settings of the air-conditioner for the season, you have to program the remote control signals of the new settings on the Commander.

If the power-on/off operation does not work correctly

The air-conditioner may not be turned on or off properly with the button or key of this Commander, for which you have programmed its power-on/off signal. If the Commander can operate only "ON" with one button or key and "OFF" with another, while your air-conditioner's remote control can operate "ON/OFF" with a single button or key, program the signal on two buttons or keys of the Commander as follows.

- 1 Clear the learned power-on/off signal. (In the example on page 51, clear the learned signal from the SYSTEM CONTROL 2 button.)
- 2 Program the signal (transmitted from the power-on/off button of the air-conditioner's remote control) for the SYSTEM CONTROL 2 button again.
- 3 Program the signal from the same button of the remote control for another button or key (for example, the SYSTEM CONTROL 3 button).

The two buttons or keys of the Commander have been programmed with the power-on signal and the power-off signal of the air-conditioner, respectively so that you can operate the air-conditioner with the Commander.

Transferring Data between Commanders

You can transfer data, such as learned signals and component code settings, between this Commander and another Sony RM-AV3000.

Transferring data

You can transfer all the data of this Commander or the data of a Component Select button or a Label key on this Commander to another Sony RM-AV3000.

To transfer all the data of the Commander

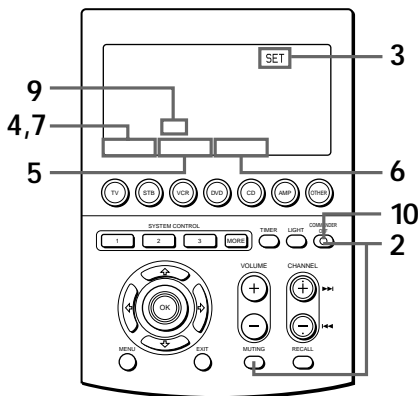

-
- 1** Place the RM-AV3000 head to head with another RM-AV3000.

Another RM-AV3000

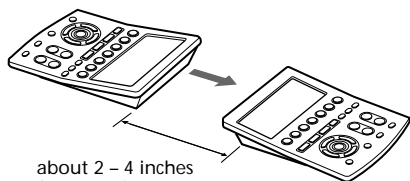

about 2 - 4 inches
(5 - 10 cm) away

RM-AV3000

-
- 2** While pressing COMMANDER OFF, press MUTING.



“SET” appears on the Mode Display key.

-
- 3** Press the Mode Display key (SET) twice to display “MODE” on one of the Label keys on the display.

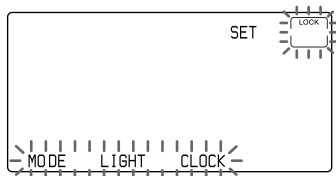

-
- 4** Press the MODE key.
“MODE” appears on the Mode Display key.

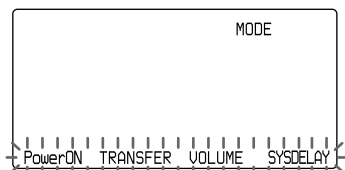

-
- 5** Press the “TRANSFER” key.



“TRANSFER” appears on the Mode Display key.

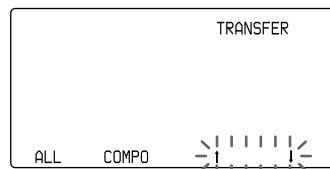

-
- 6** Press the ↑ key.



↑ : Transfer data

↓ : Receive data

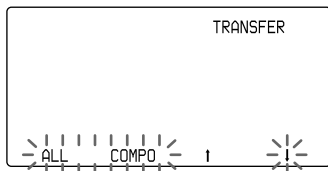

Transferring Data between Commanders (continued)

7 Press the ALL key.



- ALL: All data of the Commander
COMPO: Data of a Component Select button or a Label key

“ALL ↑” appears on the Mode Display key, and “ALL” appears on the left Label key.

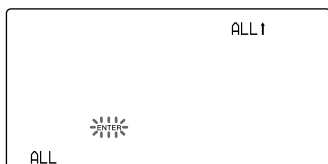

8 Confirm that the receiving Commander is ready for data. (To set the receiving commander, follow the procedure on page 56.)

9 Press the “ENTER” key.



During transferring the data, “→ → → → → → → →” flashes. When the all data has been successfully transferred, “END” appears on the right Label key.

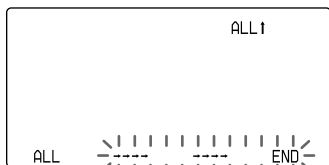

Note

If “NG” appears while sending the data, go back to Step 5 and continue the operation or press COMMANDER OFF to stop the operation.

10 Press COMMANDER OFF.



If you keep COMMANDER OFF pressed for more than 2 seconds
The Commander turns off.

If you keep COMMANDER OFF pressed for less than 2 seconds
The Commander returns to the previous setting mode.

Note

Be sure that the receiving Commander is ready to receive data.

To transfer the data of a Component Select button or a Label key

The data of a Component Select button or a Label key on this Commander (the settings and learned signals programmed on the keys and buttons) can be transferred to a Component Select button or key on another Sony RM-AV3000.

1 Follow Steps 1 to 6 on page 53.

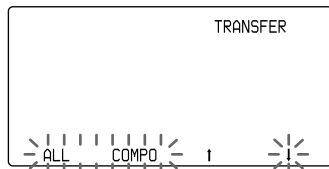

2 Press the COMPO key.



“COMPO ↑” appears on the Mode Display key, and the selected component name appears on the left Label key.

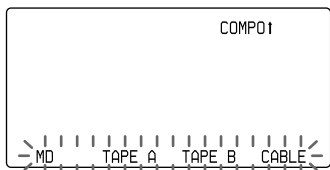

3 Press the Component Select button of which data you want to send.

Or press the Label key of which data you want to send. (To change the Label keys, press the OTHER button repeatedly.)



The component name of which contents are to be transferred appears on the left Label key.

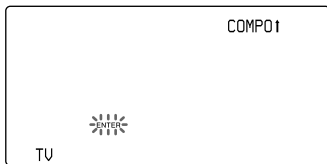

4 Confirm that the receiving remote commander is ready to accept data.

(To set the receiving commander, follow the procedure on page 56.)

5 Press the “ENTER” key.



During transferring the data, “→ → → →” flashes.

When the data has been successfully transferred, “END” appears on the right Label key.

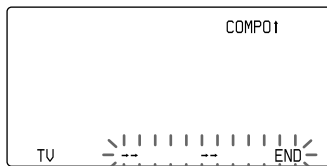

Note

If “NG” appears while sending the data, go back to Step 6 and continue the operation or press COMMANDER OFF to stop the operation.

6 Press COMMANDER OFF.

COMMANDER
OFF



If you keep COMMANDER OFF pressed for more than 2 seconds
The Commander turns off.

If you keep COMMANDER OFF pressed for less than 2 seconds
The Commander returns to the previous setting mode.

Notes

- The data of the System Control function programmed for a Component Select button cannot be transferred.
- Be sure that the receiving Commander is ready to receive data.

Transferring Data between Commanders (continued)

Receiving the data

This Commander can receive the data of another Sony RM-AV3000.

To receive all the data from another remote commander

1 Follow Steps 1 to 5 on page 53.

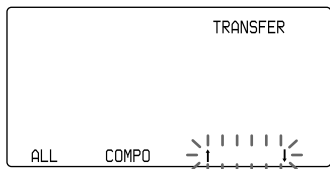

2 Press the ↓ key.



↑ : Transfer data

↓ : Receive data

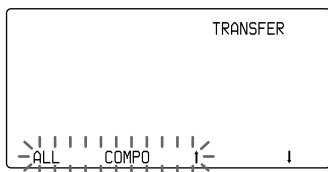

3 Press the ALL key.



ALL: All data of the Commander

COMPO: Data of a Component
Select button or a Label key

“ALL ↓” appears on the Mode Display key, and “ALL” appears on the left Label key.

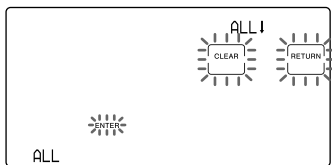

4 Press the ENTER key.



During receiving the data, “→→→→ →→→→” flashes.

When all the data has been successfully transferred, “ALL” appears on the right Label key.

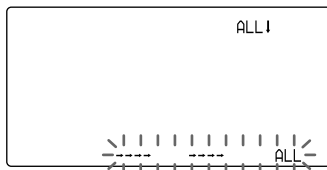

Notes

- If the Commander is not ready for receiving the data, press the CLEAR key, then press the RETURN key to clear all the learned signals.
- If “NG” appears during data transfer, go back to Step 3 and continue the operation or press COMMANDER OFF to stop the operation. If you continue the operation, you have to set the sending Commander again to send data.

5 Press COMMANDER OFF.



If you keep COMMANDER OFF pressed for more than 2 seconds
The Commander turns off.

If you keep COMMANDER OFF pressed for less than 2 seconds
The Commander returns to the previous setting mode.

To receive the data of a Component Select button or key from another remote commander

1 Perform Steps 1 and 2 on pages 56.

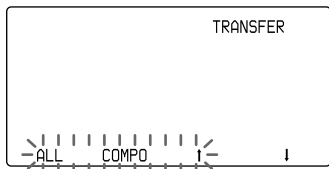

2 Press the COMPO key.



"COMPO ↓" appears on the Mode Display key.

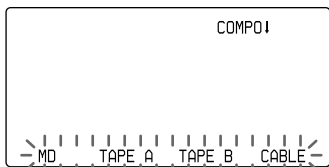

3 Press the Component Select button to which you want to assign the data.

Or press the Label key to which you want to assign the data. To change the Label keys, press the OTHER button repeatedly.



The selected component name appears on the left Label key.

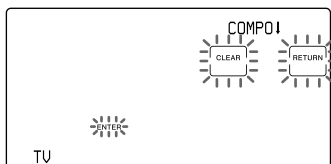

4 Press the ENTER key.



During receiving the data, "→ → →" flashes.

When the data has been successfully received, the selected component name appears on the right Label key.

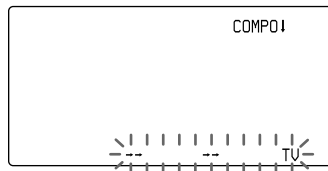

Transferring Data between Commanders (continued)

Notes

- If the Commander is not ready for receiving the data, press the CLEAR key, then press the RETURN key to clear the learned signal on all or one of the Component Select buttons.
- If "NG" appears during data transfer, go back to Step 3 and continue the operation or press COMMANDER OFF to stop the operation. If you continue the operation, you have to set the sending Commander again to send data.

5 Press COMMANDER OFF.

COMMANDER
OFF



If you keep COMMANDER OFF pressed for more than 2 seconds

The Commander turns off.

If you keep COMMANDER OFF pressed for less than 2 seconds

The Commander returns to the previous setting mode.

Selecting a Channel with a Single Key Press

— Channel Macro Function

You can program the Channel Macro function of the components of which the first digit of the four-digit preset component code number is 3 (STB), 8 (TV) or 9 (CABLE).

And you can program the Channel Macro function for the macro keys (Label keys) when the selected component name is displayed on the Mode Display key in Step 4, page 59.

If you program the operation of entering the 1, 2, 3 and ENTER keys for a macro key (Label key), you can select channel 123 by pressing that single key.

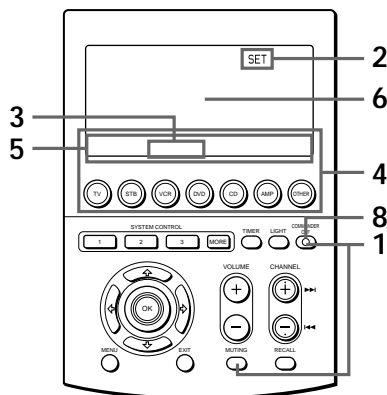

Example: To program TV channel 123 for the VIDEO4 key

- 1 While pressing COMMANDER OFF, press MUTING.



“SET” appears on the Mode Display key.

- 2 Press the Mode Display key (SET) once to display “CHMACRO” on one of the Label keys.

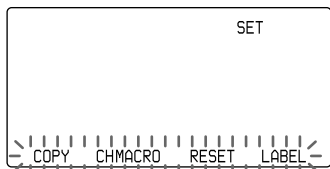

- 3 Press the CHMACRO key.



“CHMACRO” appears on the Mode Display key.

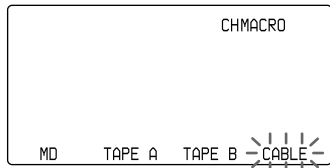

The component names on the Label keys for which the Channel Macro function can be programmed flash. To change the Label keys, press the OTHER button.

- 4 Select the component by pressing the Component Select button or the Label key.



The selected component name appears on the Mode Display key. The macro keys (Label keys) flash. To change the Label keys, press the Mode Display key (in this case, TV).

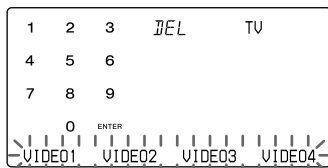

If you select the component name for which the Channel Macro function cannot be programmed “NG” flashes twice and “NG” sound is heard.

- 5 Select the macro key by pressing the Label key.



The selected label lights on the Label key. The numeric keys and “ENTER” flash.

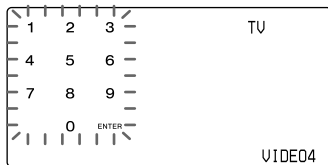

Selecting a Channel with a Single Key Press — Channel Macro Function (continued)

If you press the Label key for which the Channel Macro function cannot be programmed

“NG” flashes twice and “NG” sound is heard.

To change the name of the macro key (Label key)

Keep the macro key (Label key) pressed for more than 2 seconds, and follow Steps 2 - 5, page 24.

-
- 6** Press the keys for the operation in order (1 → 2 → 3 → ENTER).

Note

If you enter more than four keys, the last four keys are programmed for the macro key.

-
- 7** Press the macro key (in this case, VIDEO 4).

“1,” “2,” “3,” and “ENTER” appear twice.

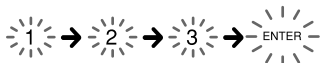

-
- 8** Press COMMANDER OFF.



If you keep COMMANDER OFF pressed for more than 2 seconds

The Commander turns off.

If you keep COMMANDER OFF pressed for less than 2 seconds

The Commander returns to the previous setting mode.

Note

You cannot program the Channel Macro function for a macro key that has “learned” a signal. Try again with another macro key, or clear the “learned” signal (page 25) from the button and program the Channel Macro function on it.

To clear the Channel Macro function

- 1 While pressing COMMANDER OFF, press MUTING.
- 2 Press the SET key.
- 3 Press the CHMACRO key.
- 4 Select the component by pressing the Component Select button or the Label key.
- 5 While pressing the DEL key, press the macro key.

Note

You can also clear the character contents you input by following the procedure above repeatedly.

Setting the Timer

Up to 12 timer setting programs can be set on this commander. You can program the timer setting of the day of the week, the hour, the minute and the contents of the program (Timer Macro). You can set each program of the timer to be executed or not.

There are two ways for the timer setting as below.

- Setting the new timer program
- Changing the program already set or changing another program that you select (page 65)

Setting the new timer program

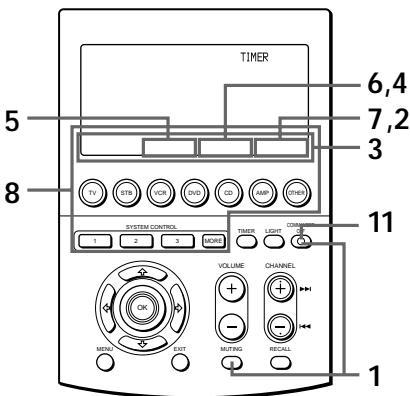

Example: To set the timer program at 7:30 AM on Saturday to the PROG4 key

- 1 While pressing COMMANDER OFF, press MUTING.



"SET" appears on the Mode Display key.

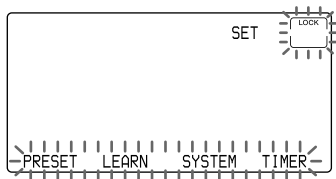

- 2 Press the TIMER key.



"TIMER" appears on the Mode Display key.

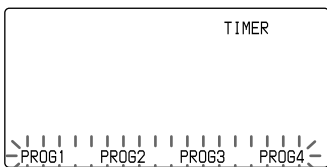

The program numbers "PROG1" - "PROG4" appears on the Label keys. To change the Label keys, press the TIMER button on the Commander repeatedly.

The program numbers having timer setting programs which are set to be executed (stand-by mode) stay lit. The program numbers having timer setting programs which are set not to be executed flash. The program numbers without timer setting programs flash.

Setting the Timer (continued)

- 3** Select the program number to which you want to set the timer by pressing the Label key.



The selected program number appears on the Mode Display key. (If the pressed Label key has character contents you input, the character contents appear on the Mode Display key.)

"ON/OFF," "TEST," "SETUP," and "COPY" flash on the Label keys.

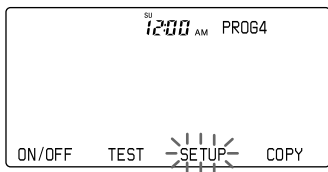

"SU" and "12:00 AM" are displayed on the Clock Display key.

If the day of the week and the time for the timer program are set in this setting mode, or if you try changing the program already set (page 65), the set contents are displayed on the Clock Display key.

- 4** Press the SETUP key.



"DAY," "TIME" and "MACRO" flash on the Label keys.

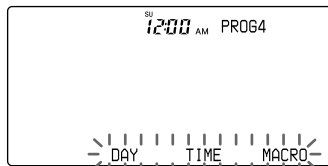

- 5** Press the DAY key, and set the timer-on day(s) of the week by pressing the \uparrow or \downarrow button.

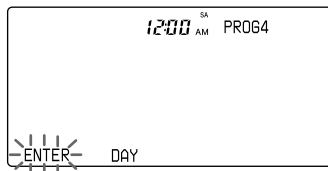

Each time the \Leftarrow or \Rightarrow button is pressed the display of day(s) of the week changes as follows.

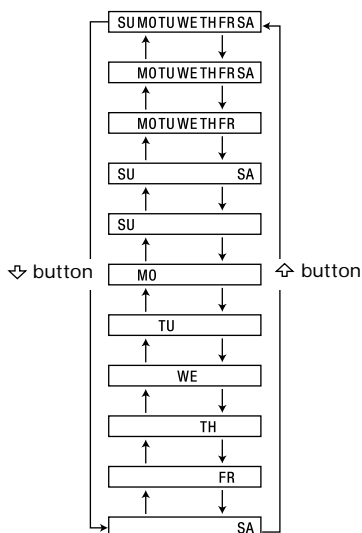

- SU : Sunday
- MO : Monday
- TU : Tuesday
- WE : Wednesday
- TH : Thursday
- FR : Friday
- SA : Saturday

Then press the ENTER key to decide the day(s).

The display returns to step 4.

6 Press the TIME key.

Set the timer-on hour by pressing the \Leftarrow or \Rightarrow button. Then press the \Rightarrow button so that the minute flashes.

(You can switch the mode between the hour setting and the minute setting by pressing the \Leftarrow or \Rightarrow button.)

Set the minute by pressing the \Leftarrow or \Rightarrow button. Then press the ENTER key.

The time of the timer setting is decided.

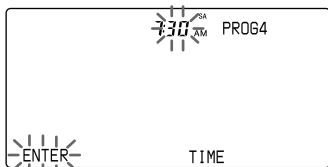

The display returns to step 4.

7 Press the MACRO key.

The Commander enters the Timer Macro setting mode.

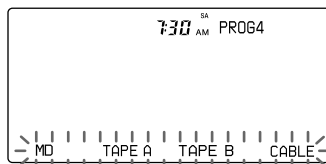

Setting the Timer (continued)

- 8** Press a Component Select button, a SYSTEM CONTROL button, or a Label key to program the information of that button or key as a procedure to be executed by the timer.

When selecting a Label key for a component name, press the OTHER button to change the Label keys. When selecting a Label key for a system number, press the MORE button to change the Label keys.

If you select a component name

Function keys for the component are displayed. Go to Step 9.

If you select a system number

Go to Step 10.

- 9** Press a button or a key of which function you want to program as a step.
-

- 10** Repeat Steps 8 and 9.

When 32 steps are input, the Macro step programming finishes with a beep sound, and a series of Macro procedure appears on the display window.

And the display returns to step 3.

Notes

- You can input up to 32 steps for one timer program number.
- A System Macro can be input as a step.
- A macro programmed for the Component Select button or the Label key is available as the same setting as its output setting.
- The step of the TIMER button has an interval of 250ms.
- The Mode Display key, the OTHER button, the LIGHT button and the MORE button are not counted as steps.

-
- 11** When you have programmed a series of Timer Macro setting, press COMMANDER OFF.



With a beep sound, a series of Timer Macro setting is registered and displayed in order.

When you have programmed the buttons on the Commander

The names of buttons on the Commander which are not on the LCD touch key display (VOLUME +/-, MUTING, CHANNEL +/-, RECALL, MENU, OK, EXIT, ⏪, ⏩, ⏴, and ⏵) are displayed on the right Label key.

The display returns to Step 3.

If you want to check the execution of the timer setting or set the timer program to the standby mode

See page 67.

If you keep COMMANDER OFF pressed for more than 2 seconds

The timer setting of the program is decided, and the Commander turns off. In this case, the timer program is not set to the standby mode.

Note

Some programs cannot be executed at the set time because the execution time of the remote control output is different depending on the contents of the timer execution. Or, if the execution time arrives while the previous timer program is outputted, the timer program begins after the execution of the previous one. In this case also, the program cannot be executed at the set time. So, set the timer regarding the contents and the duration of the timer execution.

To change the program name on the Mode Display key

After Step 3, hold the Mode Display key pressed for more than 2 seconds. The Commander enter the Label Inputting mode.

Then follow the same procedure as that for changing the name of the Label key in Steps 2 - 5 on page 24.

To change the interval between timer operation steps

See page 40.

Notes

- When using the timer setting on this Commander, only one setting can be assigned to one program. If you want to set the timer to turn on at a programmed time, and to set the timer to turn off at another time, program the two settings separately.
- If there are some programs set to be executed at the same time, they start in order from the lowest program number.
- According to the status of the component operated by the timer program, the next program might not function successfully. When setting a timer program, check carefully the setting of other programs.

Changing the program already set or changing another program that you select

1 Follow Steps 1 - 3 on page 61, 62.

2 Press the COPY key.

If you want to change the program already set, go to Step 6 without pressing the COPY key.

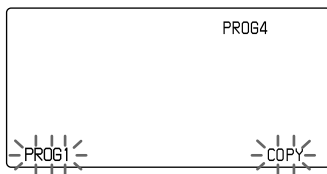

The program number appears on the left Label key, and "COPY" flashes on the right Label key.

3 Press the COPY key repeatedly until the program number of which contents you want to change appears. (Each time the COPY key is pressed, the program number which has the timer setting information appears in order.)

Setting the Timer (continued)

- 4** When the program number of which contents you want to change appears on the left Label key, press that Label key.

With a beep sound, the contents of selected program is copied to the program number on the Mode Display key (in this case, PROG4). The day of the week and the time for the copied timer program are displayed on the Clock Display key. “ON/OFF,” “TEST,” “SETUP,” and “COPY” flash on the Label keys.

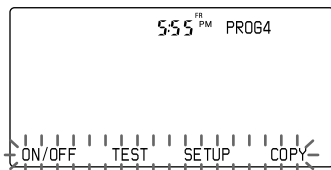

- 5** Press the SETUP key.
“DAY,” “TIME,” and “MACRO” flash.

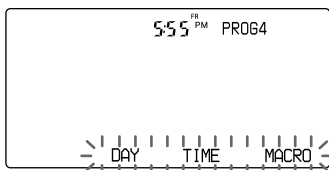

- 6** Press the key of which contents you want to change.
DAY: See Step 5 on page 62.
TIME: See Step 6 on page 63.
MACRO: The display turns as below.

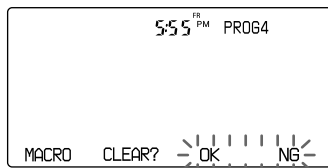

- 7** Press the OK key.
With a beep sound, the Timer Macro setting is cleared, and the Commander enters the Timer Macro setting mode (Step 7 on page 63).

If you press the NG key

The display returns to Step 5.

Note

You cannot change the Timer Macro setting partially. If you want to change the program without clearing the frequently used procedure, use the System Control function (page 31). For example, if Steps A to D are frequently used when you want to program Steps A, B, C, D and E, program Steps A to D using the system macro. Then program Step E in the Timer Macro adding to that system macro.

To check the execution of the timer program or set the timer program to the standby mode

1 Follow Steps 1 - 3 on page 61, 62.

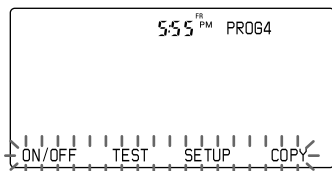

2 Press the TEST key or the ON/OFF key.

TEST: You can check the timer program setting by transmitting the Timer Macro signals.

ON/OFF: The display turns as below.

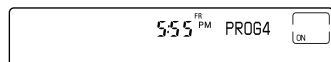

With a beep sound, "ON" appears, and the Commander enters the timer standby mode. The display returns to Step 2 on page 61.

To reset the timer standby mode, press the ON/OFF key again.

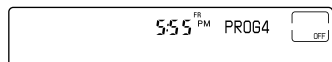

3 Press COMMANDER OFF.

COMMANDER
OFF



If you keep COMMANDER OFF pressed for more than 2 seconds
The Commander turns off.

If you keep COMMANDER OFF pressed for less than 2 seconds
The Commander returns to the previous setting mode.

Setting the Timer (continued)

To switch quickly the timer standby mode to on or off using the **TIMER** button

1 Press the **TIMER** button.

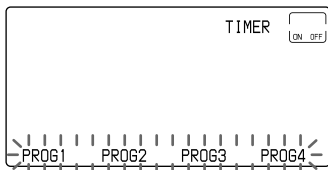

The program numbers of which timer program is set to the standby mode stay lit, and the other program numbers flash on the Label keys. To change the Label keys, press the **TIMER** button repeatedly.

2 Select the program number of which timer standby mode you want to switch to on by pressing the Label key.

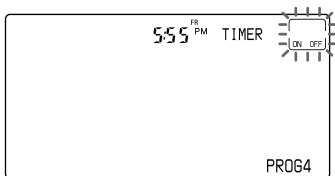

If you select the program number which has no timer program data, the "NG" sound is heard and "NG" flashes twice.

3 Press the **ON OFF** key.

With a beep sound, "☺" mark lights and the standby mode of the selected timer program is set to on. The display returns to Step 1.

4 Keep **COMMANDER OFF** pressed for more than 2 seconds to turn the Commander off.

To reset the standby mode to off, follow Steps 1 - 3 again.

Notes

- If the **TEST** key or the **ON/OFF** key is pressed when the timer program is not set, the "NG" sound is heard twice and "NG" flashes.
- When you finish the timer setting mode after you set the timer standby mode, "☺" mark stays lit beside the clock. This means that one or more timer programs are set to the timer standby mode.
- The timer program contents you have set on this Commander repeat every week until you set the timer standby mode to **OFF** (weekly timer). If you want to execute the timer program once, set the timer standby mode to **OFF** after the execution of the timer program.

IMPORTANT

The timer function of this Commander is designed for the timer operation of AV components. Do not use the timer function to operate an air-conditioner or electrical appliances. It may cause a fire or a serious injury.

To clear timer settings programmed for a specific PROG (1-12) Label key

- 1 While pressing COMMANDER OFF, press MUTING.

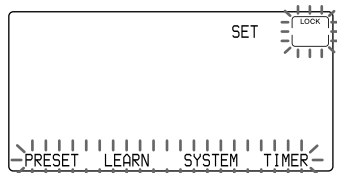

- 2 Press the Mode Display key (SET) once to display "RESET" on one of the Label keys on the display.

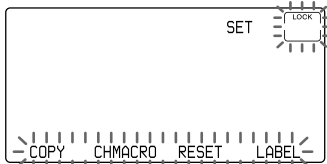

- 3 Press the RESET key. "RESET" appears on the Mode Display key.

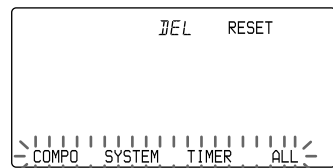

- 4 Press the TIMER button.

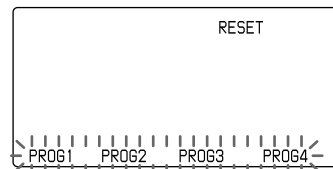

"PROG1" - "PROG4" are displayed. To change the Label keys, press the TIMER button.

- 5 Press the Label key of which timer settings you want to erase. The selected program number is displayed on the left Label key.

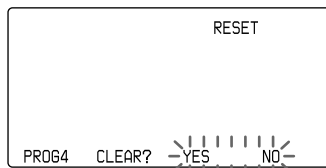

- 6 Press the YES key. During erasing, "→ →" stays lit. When erasing finishes, "OK" is displayed with a beep sound.

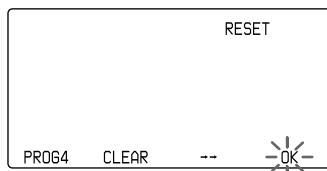

If you press the NO key
The display returns to Step 4.

- 7 Press COMMANDER OFF.



If you keep COMMANDER OFF pressed for more than 2 seconds
The Commander turns off.

If you keep COMMANDER OFF pressed for less than 2 seconds
The Commander returns to the previously set mode.

Setting the Timer (continued)

To clear all timer settings programmed for all PROG (1 - 12) Label keys

1 Proceed Steps 1 - 3 on page 69.

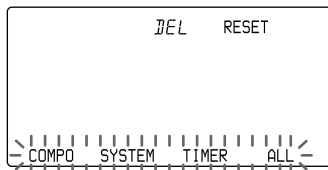

2 While pressing the DEL key, press the TIMER key.

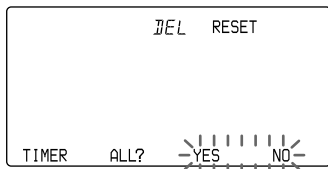

3 Press the YES key.

"REALLY?" stays lit, and "YES" and "NO" flash.

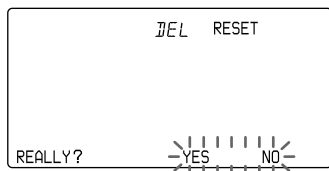

If you press the NO key
The display returns to Step 1.

4 Press the YES key.

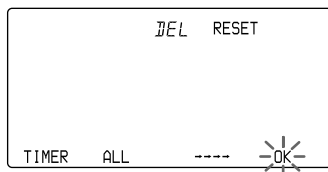

If you press the NO key
The display returns to Step 1.

During erasing, "→→→→" stays lit. When all timer settings programmed for all PROG (1 - 12) Label keys are erased, "OK" is displayed with a beep sound.

5 Press COMMANDER OFF.



If you hold COMMANDER OFF pressed for more than 2 seconds
The Commander turns off.

If you hold COMMANDER OFF pressed for less than 2 seconds
The Commander returns to the previous setting mode.

Locking the Controls

— Hold Function

To prevent accidental operation, you can lock all the buttons with the Hold function. However, the timer functions while the controls are locked.

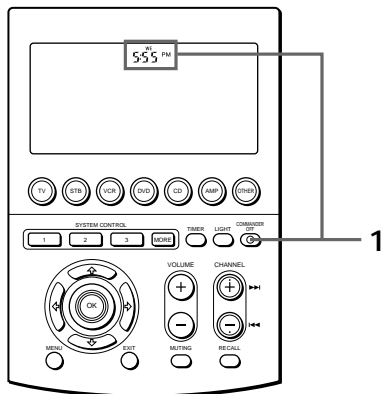

When the controls are locked

When you press a button on the Commander, the “NG” sound is heard twice, and “LOCK”, the clock, and “⊖” mark (when the timer is set to be executed) are displayed for a second.

To unlock the controls

Keep COMMANDER OFF pressed for more than 2 seconds.

COMMANDER
OFF



With a key-touch sound, the display returns to the status before setting of the Hold function.

- 1 While pressing the Clock Display key, press COMMANDER OFF.

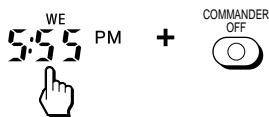

With a beep sound, “LOCK” appears on the Mode Display key, and every LCD display disappears except the clock and “LOCK.”

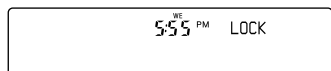

After a second, every LCD display disappears.

Protecting your Settings

— Setting Lock Function

You can lock the Commander so that you cannot change, add, or clear any of your data in each setting mode.

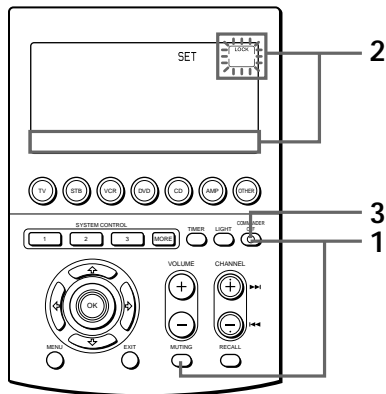

- 1 While pressing COMMANDER OFF, press MUTING.



“SET” appears on the Mode Display key, “LOCK” flashes and setting modes flash on the Label keys.

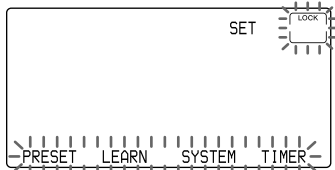

- 2 While pressing the LOCK key, press the Label key on which the setting mode you want to lock is displayed. (To change the Label keys, press the SET key.)

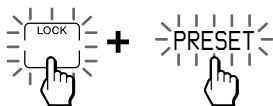

The selected setting mode is locked and the display of the locked setting mode on the Label key stays lit.

To lock other setting modes, repeat Step 2.

- 3 Press COMMANDER OFF.



When the setting is locked

If you try to display the locked setting mode by pressing the Label key, “NG” will flash and the “NG” sound is heard twice.

To unlock the setting

Follow Steps 1 and 2. And while pressing the LOCK key, press the Label key on which the setting mode you want to unlock is displayed. (To change the Label keys, press the SET key.) When the setting is unlocked, the display of the setting mode on the Label key flashes.

Setting the Automatic-Off Time of the Display Window

The Commander is preset at the factory to turn off the LCD display window automatically if you do not operate for more than 10 minutes. (Then all the display contents are turned off.) To change this setting, perform the following procedure.

You can adjust the Automatic-Off time of the LCD display window (from 1 minute to 30 minutes in units of 1 minute).

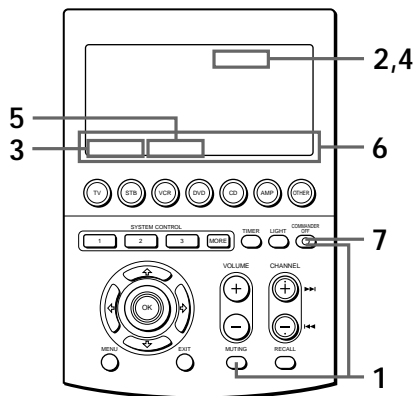

- 1 While pressing COMMANDER OFF, press MUTING.



“SET” appears on the Mode Display key.

- 2 Press the Mode Display key (SET) twice to display “MODE” on one of the Label keys.

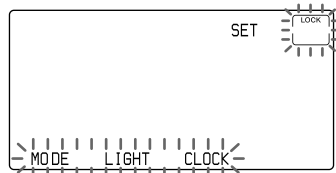

- 3 Press the MODE key. “MODE” appears on the Mode Display key.

- 4 Press the Mode Display key (MODE) once to display “DISP-OFF” on one of the Label keys. Each time you press the MODE key, the Label keys changes as follows.

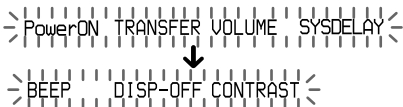

- 5 Press the DISP-OFF key. “DISP-OFF” appears on the Mode Display key.

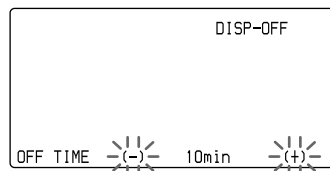

Setting the Automatic-Off Time of the Display Window (continued)

- 6** Press the (+) or (-) key to change the Automatic-Off time of the LCD display window. You can adjust from 1 minute to 30 minutes. Each time the (+) key is pressed, the minute increases by one. Each time the (-) key is pressed, the minute decreases by one. For example, "2min" on the Label key means 2 minutes.

Note

When you set the Automatic-Off time of the display window longer than 10 minutes (factory setting), the battery life may be short.

- 7** Press COMMANDER OFF.



If you keep COMMANDER OFF pressed for more than 2 seconds
The Commander turns off.

If you keep COMMANDER OFF pressed for less than 2 seconds
The Commander returns to the previous setting mode.

Adjusting the Backlight of the Display Window

The Commander is preset at the factory to brighten backlight, and to switch off the backlight automatically if you do not operate for more than 10 seconds. To change this setting, perform the following procedure.

You can adjust the backlight Automatic-Off time (from 1 second to 60 seconds in the units of 1 second), the brightness (bright or dim) and the setting of the buttons to lighten the Display Window.

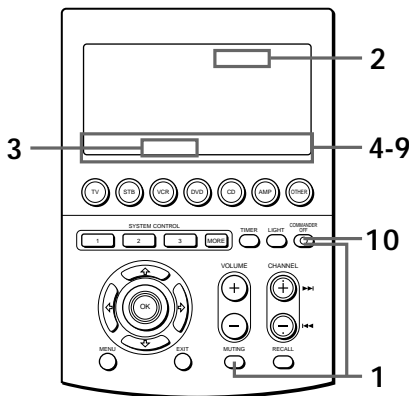

- 1** While pressing COMMANDER OFF, press MUTING.



"SET" appears on the Mode Display key.

-
- 2** Press the Mode Display key (SET) twice to display “LIGHT” on one of the Label keys.

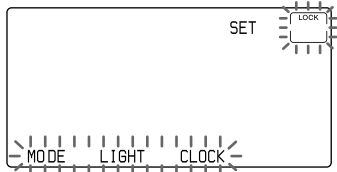

-
- 3** Press the LIGHT key.

“LIGHT” appears on the Mode Display key.

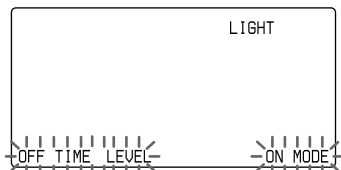

-
- 4** Press the OFF TIME key.

The display becomes in the setting mode of the Automatic-Off time of the backlight.

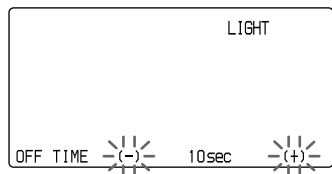

-
- 5** Press the (+) or (-) key to change the Automatic-Off time of the backlight. Then press COMMANDER OFF to decide the Automatic-Off time of the backlight. The display returns to Step 3.

You can adjust from 1 second to 60 seconds.

Each time the (+) key is pressed, the second increases by 1.

Each time the (-) key is pressed, the second decreases by 1.

For example, “20sec” on the Label key means 20 seconds.

Note

When you set the Automatic-Off time of the backlight longer than 10 seconds (factory setting), the battery life may be short.

If you hold COMMANDER OFF pressed for more than 2 seconds

The setting is decided, and the Commander turns off.

-
- 6** Press the LEVEL key.

The display becomes in the brightness setting mode. The current setting (BRIGHT or DIM) stays lit. The other flashes.

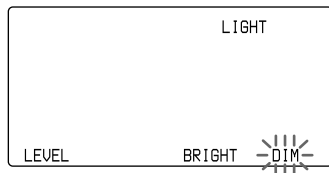

Adjusting the Backlight of the Display Window (continued)

- 7** Press the BRIGHT or DIM key to select the brightness. Then press COMMANDER OFF to decide the brightness.

The display returns to Step 3.

BRIGHT: bright

DIM: dark

- 8** Press the ON MODE key.

The commander enter the setting mode to select the buttons to lighten the display window. The current setting (LIGHT or ALL) stays lit. The other flashes.

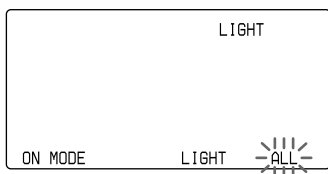

-
- 9** Press the LIGHT or ALL key to select the buttons on the Commander to light the display window.

If you press COMMANDER OFF, the display returns to Step 3.

LIGHT: The Display Window is lit by pressing the LIGHT button only.

ALL: The Display Window is lit by pressing any button on the Commander except the VOLUME +/-, MUTING, CHANNEL +/-, RECALL and COMMANDER OFF.

Note

If you use the Commander frequently with the "ALL" position, the battery life may be short. In this case, shorten the Automatic-Off time (page 73, 74).

- 10** Press COMMANDER OFF.



If you keep COMMANDER OFF pressed for more than 2 seconds

The Commander turns off.

If you keep COMMANDER OFF pressed for less than 2 seconds

The Commander returns to the previously set mode.

Setting the Key-Touch Beep

The Commander is preset at the factory to turn on the key-touch confirmation beep. You can turn on or off the key-touch confirmation beep.

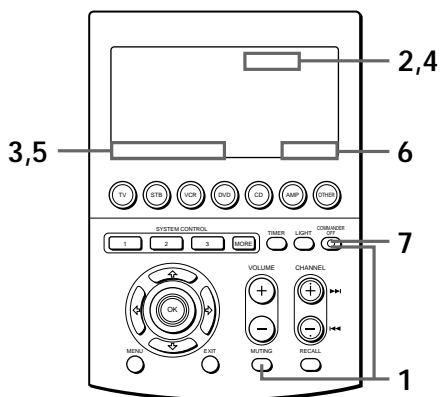

- 1 While pressing COMMANDER OFF, press MUTING.



“SET” appears on the Mode Display key.

- 2 Press the Mode Display key (SET) twice to display “MODE” on one of the Label keys.

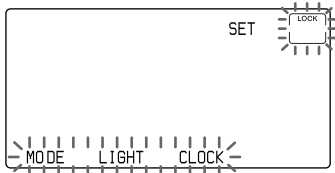

- 3 Press the MODE key.
“MODE” appears on the Mode Display key.

- 4 Press the Mode Display key (MODE) once to display “BEEP” on one of the Label keys.

- 5 Press the BEEP key.

“BEEP” appears on the Mode Display key.

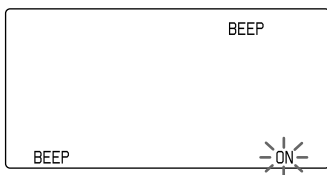

- 6 Press the ON (or OFF) key. Each time you press the key, the display changes between “ON” and “OFF” with a beep sound. The display of the current setting flashes.

ON: Turns on the key-touch beep.
OFF: Turns off the key-touch beep.

- 7 Press COMMANDER OFF.



If you keep COMMANDER OFF pressed for more than 2 seconds
The Commander turns off.

If you keep COMMANDER OFF pressed for less than 2 seconds
The Commander returns to the previous setting mode.

Adjusting the Contrast of the Display Window

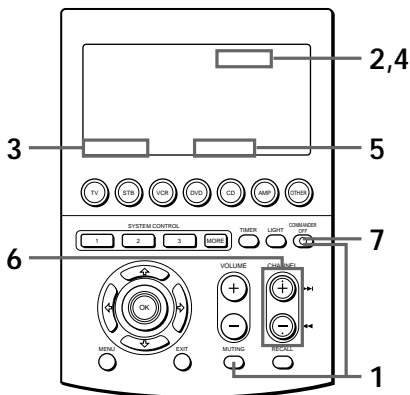

- 1 While pressing COMMANDER OFF, press MUTING.



“SET” appears on the Mode Display key.

- 2 Press the Mode Display key (SET) twice to display “MODE” on one of the Label keys.
- 3 Press the MODE key.
“MODE” appears on the Mode Display key.

- 4 Press the Mode Display key (MODE) once to display “CONTRAST” on one of the Label keys.

- 5 Press the CONTRAST key.
“CONTRAST” appears on the Mode Display key. “****” appears on each Label key. The DVD display appears on the other part of the display window.

- 6 Press the CHANNEL + or CHANNEL - button to adjust the contrast of the display window.
Each time you press the button the contrast changes as follows.

CHANNEL +: Deeper than the actual contrast setting
CHANNEL -: Lighter than the actual contrast setting

- 7 Press COMMANDER OFF.



If you keep COMMANDER OFF pressed for more than 2 seconds
The Commander turns off.

If you keep COMMANDER OFF pressed for less than 2 seconds
The Commander returns to the previously set mode.

Changing the Names of the Label Keys or the Component Names on the Mode Display Key

You can change the display of the Component names on the Mode Display key or on the Label keys, the function displays of components, the SYSTEM4 - SYSTEM15 and PROG1 - PROG12 on the Label keys to the most suitable name using up to 8 characters or digits.

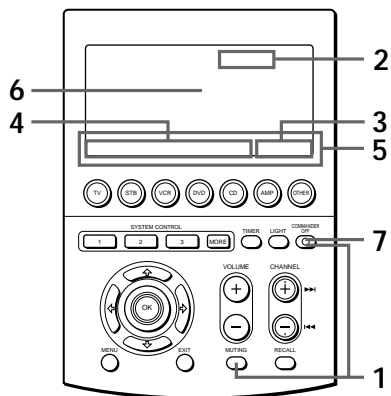

- 1 While pressing COMMANDER OFF, press MUTING.



“SET” appears on the Mode Display key.

- 2 Press the Mode Display key (SET) once to display “LABEL” on one of the Label keys on the display.

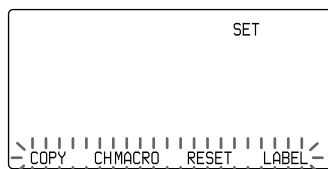

- 3 Press the LABEL key.

“LABEL” appears on the Mode Display key.

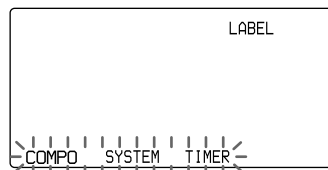

Changing the Names of the Label Keys or the Component Names on the Mode Display Key (continued)

- 4 Select the sort of Labels by pressing the COMPO, SYSTEM or TIMER key.

COMPO: Displays component names. To change the Label keys, press the OTHER button.
Press the component select button or the Label key of which the name you want to change.

To change the component name on the Mode Display key

Keep the Mode Display key on which the component name is displayed pressed for more than 2 seconds. The Commander enters the component name changing mode.

Input the name on the Mode Display key.
Follow Steps 2-5, on page 24.

SYSTEM: Displays SYSTEM4 - SYSTEM7. To change the Label keys, press the MORE button.

TIMER: Displays PROG1 - PROG4.
To change the Label keys, press the TIMER button.

- 5 Press the Label key of which the name you want to change.

The commander enters the Label name changing mode.

COMPO:(Example : TV-VIDEO2)

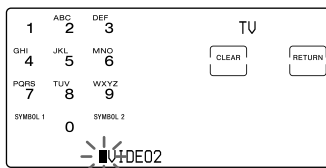

SYSTEM:(Example : SYSTEM6)

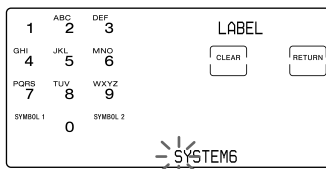

TIMER:(Example : PROG10)

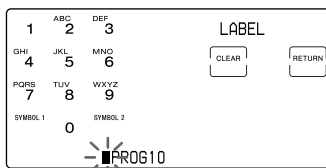

-
- 6** Input the name of the Label key.
Follow Steps 2 - 5, on page 24.
-

- 7** Press COMMANDER OFF.

COMMANDER
OFF



If you keep COMMANDER OFF pressed for more than 2 seconds
The Commander turns off.

If you keep COMMANDER OFF pressed for less than 2 seconds
The Commander returns to the previous setting mode.

Erasing All the Settings

You can erase all the settings to reset the Commander to its factory settings.

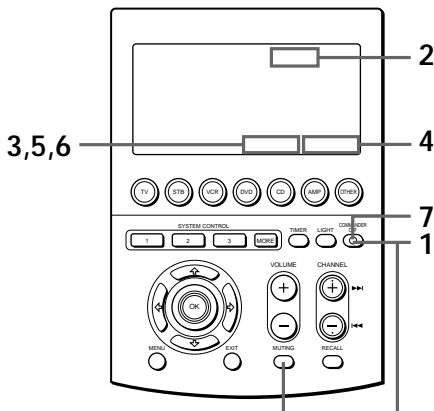

-
- 1** While pressing COMMANDER OFF, press MUTING.

COMMANDER



+

MUTING



“SET” appears on the Mode Display key.

- 2** Press the Mode Display key (SET) once to display “RESET” on one of the Label keys on the display.

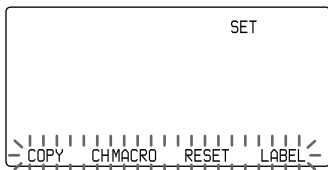

Erasing All the Settings (continued)

- 3** Press the RESET key.
“RESET” appears on the Mode Display key.

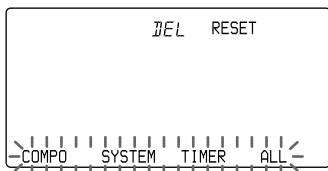

- 4** Press the ALL key.



“ALL RESET?” stays lit, and “YES” and “NO” flash.

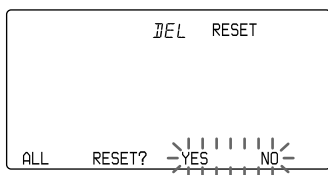

- 5** Press the YES key.
“REALLY?” stays lit, and “YES” and “NO” flash.

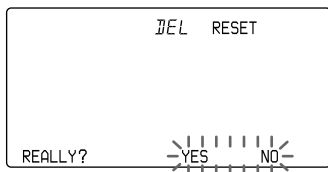

If you press the NO key
The display returns to Step 3.

- 6** Press the YES key.

During erasing, “ALL → → → → → → → →” stays lit. When all the settings on the Commander are erased, “OK” is displayed with a beep sound. The Commander is reset to its factory settings.

If you press the NO key
The display returns to Step 3.

- 7** Press COMMANDER OFF.

COMMANDER
OFF



If you keep COMMANDER OFF pressed for more than 2 seconds
The Commander turns off.

If you keep COMMANDER OFF pressed for less than 2 seconds
The Commander returns to the previous setting mode.

Precautions

- Do not drop the unit or give a shock to the unit, or it may cause a malfunction.
- Do not leave the unit in a location near heat sources, or in a place subject to direct sunlight, excessive dust or sand, moisture, rain or mechanical shock.
- Do not put foreign objects into the unit. Should any liquid or solid object fall into the unit, have it checked by qualified personnel before operating the unit any further.
- Do not expose the remote control detectors of your components to direct sunlight or other strong illumination. Too much light there can interfere with remote control operations.
- Be sure to place the Commander out of the reach of small children or pets. Components such as air conditioners, heaters, electric appliances, and electric shutters or curtains receiving an infrared signal can be dangerous if misused.

Maintenance

Clean the surface with a soft cloth slightly moistened with water or a mild detergent solution. Do not use any type of solvent such as alcohol, benzine or thinner as they may damage the finish of the surface.

Specifications

Operating distance

Approx. 32.8 ft. (10 meters) (varies depending on components of different manufacturers)

Power requirements

Remote control and backlight: Four size AA (R6) batteries

Battery life

Approx. 5 months (varies depending on frequency of use)

Dimensions

Approx. $4\frac{3}{4} \times 7 \times 1\frac{1}{2}$ in. (w × h × d)
(120 × 175 × 38 mm)

Mass

13 oz. (380 g) (not including batteries)

Learnable signals*

Capacity per signal: up to 300 bit
Signal frequency range: up to 500 kHz
Signal interval: up to 1 second

* Some signals cannot be learned by the Commander, even though the signals comply with these specifications.

Design and specifications are subject to change without notice.



The CE mark on the unit is valid only for products marketed in the European Union.

Troubleshooting

If you have problems setting up or using the Remote Commander, first check the batteries (page 7), then check the items below.

Symptom	Remedy
You cannot operate the components.	<ul style="list-style-type: none">• Go closer to the component. The maximum operating distance is approximately 32.8 ft. (10 m).• Check that you are aiming the Commander directly at the component, and that there are no obstructions between the Commander and the component.• Turn on the components first, if necessary.• Check that the component has infrared remote capability. For example, if your component didn't come with a remote commander, it probably isn't capable of being controlled by a remote commander.• You have assigned a different component to the Component Select button or Label key. A corresponding component is fixed by presetting a component code number. Therefore, the name of component you have preset may be different from that of the Component Select button or the Label key. In this case, it is recommended to preset again (page 12) and change the component name on the Mode Display key or the name of the Label key (page 23, 24).
You cannot operate the components even after setting the component code numbers.	<ul style="list-style-type: none">• Set the component code correctly. If the code that is listed first for your component doesn't work, try all the codes for your component in the order in which they are listed in the supplied "Component Code Numbers".• Some features may not be preset. If some or all of the keys do not function correctly even after you have set the component codes, then use the learning function to program the remote control signals for the component (page 19).
You cannot control the volume.	<ul style="list-style-type: none">• If your visual components are connected to an audio system, make sure you've set up the Commander as described in "Controlling the Volume of Visual Components Connected to an Audio System" (page 29).• You have assigned another component to the TV or AMP button (page 45, 46). In this case, the volume cannot be controlled when you select a component other than TV or AMP.
The Commander fails to learn the remote control signals.	<ul style="list-style-type: none">• When you teach signals of an interactive signal exchange system remote control unit (supplied with some of Sony's receivers and amplifiers) to the Commander, the response signal of the main unit may interfere with the learning of the Commander. In such a case, move to a place where the signals will not reach the main unit (e.g. other rooms, etc.).
You cannot operate a component even after you programmed the remote control signals with the "learning" function.	<ul style="list-style-type: none">• Make sure that the Remote Commander has learned the correct signals. If not, see "For accurate learning" (page 25) and try the learning procedure again (page 19).

Symptom	Remedy
"NG" flashes five times.	<ul style="list-style-type: none"> • Learning has not succeeded. After checking the follows, try learning procedure again (page 19). <ul style="list-style-type: none"> - Change the distance between remote commanders. - See "For accurate learning" (page 25). • The component codes cannot be set. See the supplied "Component Code Numbers" and try setting the component codes again (page 12). • The data have not been transferred. See "Transferring data" (page 52) and try transferring the data again. • The data has not been received. See "Receiving the data" (page 56) and try receiving the data again.
"NG" flashes twice.	<ul style="list-style-type: none"> • Learned signals have been programmed for the button or key to which you want to set the learning, System Control or Channel Macro function. Clear the learned signals (page 35, 60) and try setting again. • Learned signals or the Channel Macro function have been programmed for the Component Select button or the Label key to which you want to copy the settings of another Component Select button or the Label key using the copying function (page 47). Clear the contents (page 25, 60) and try the copying procedure again. • The key for which you want to program the Channel Macro function is not a Channel Macro key. You can program the Channel Macro function only for the Label keys. • You may try to clear the learned signals in the Channel Macro setting mode (page 60). In this mode, only Channel Macro settings can be cleared by pressing the macro key while keeping the DEL key pressed. To clear the learned signals, see page 46. • Learned signals have been programmed for the Label key to which you want to set the Channel Macro function. Clear the learned signals (page 25) and try setting again. Or set to another Label key. • There are some keys, for which learned signals have been programmed, on the display for the Component Select button or the Label key when the Commander receives the data from another Commander. Clear the learned signals using the CLEAR key and the RETURN key on the display of the receiving mode (page 56). Or see "Changing or erasing the function of a taught key or button" (page 25), and clear the learned signals. • The program contents you want to change are set to be executed by the timer. Set the timer setting in which that program is included not to be executed (page 65), and edit the program contents. • You may try to program the Power-On function (page 43) for a Component Select button or the Label key to which the component code of a non-Sony product has been set. This function is only for Sony components. • You may try to operate the preset function (page 12) after operating the learning function (page 19). You cannot operate the preset function after operating the learning function. Preset after clearing the learned signals (page 25), or preset to another Component Select button or Label key that is not used.

Troubleshooting (continued)

Symptom	Remedy
"NG" appears during learning.	<ul style="list-style-type: none">• The memory is full. Clear infrequently used learned keys (page 25), then carry out learning operations.
"NG" flashes if you try to copy the settings of the Component Select button or the Label key to another Component Select button or Label key.	<ul style="list-style-type: none">• There are some keys, for which learned signals or the Channel Macro function have been programmed, on the display for the Component Select button or the Label key. Copy the settings to another Component Select button or the Label key, or clear the learned signals (page 25) or the Channel Macro function (page 60).
A system control program does not function correctly.	<ul style="list-style-type: none">• Make sure that you have programmed the commands in the correct order (page 31).• Try changing the orientation of the Commander. If that does not help, try placing the components as close to each other as possible.• Check the status of the components and make sure that you have set the components properly to receive commands (page 37).• The component codes are changed or a new signals have been learned for a key or button that has been programmed with a series of commands. In this case, the new signals are transmitted when the series of commands is executed.• The interval may be too short. See "Changing the interval between operation steps" (page 40) and set a longer interval, or adjust the series of commands by changing the order of buttons and keys. (When programming the system control function, you can make an interval of a while by pressing the TIMER button.)
Your Commander does not work as expected after data transfer.	<ul style="list-style-type: none">• Data transfer to/from a single Component Select button or Label key cannot transfer System Control functions set to each button or key. Either set up the receiving Commander from the start, or perform whole data transfer (page 52).
The component set to be operated by the timer of the Commander does not function as expected.	<ul style="list-style-type: none">• The component could not receive the signal from the Commander successfully. When using the timer, check the following.<ul style="list-style-type: none">- Check that the timer macro program functions correctly by pressing the TEST key, after programming the timer (page 66).- Check the location of the Commander.• The status of each component is not suitable for operation. (For example, you program the power-on setting, assuming that power of the component is off when the timer turns on. However, if power of the component is on when the component receives the timer signal from the Commander, the component will turn off.)
The timer program is executed in the next week though that program has been already executed.	<ul style="list-style-type: none">• The timer program contents you have set on this Commander repeat every week (weekly timer). If you want to execute the timer program once, set the timer standby mode to OFF after checking the execution of the timer program (page 67).
The character contents you have input return to the original display.	<ul style="list-style-type: none">• If you preset a component code after inputting character contents, they are cleared and return to the original display. Edit the characters after you decide the component to be used by presetting a code.
The character contents you have input are not displayed.	<ul style="list-style-type: none">• If you input characters to the Label keys which have no data (displayed "****"), the input characters are not displayed. In this case, first input data to the Label keys by learning function (page 19) and input characters. However, the input characters are displayed during the learning operation.

Symptom	Remedy
The display of the Commander turns off by itself.	<ul style="list-style-type: none"> • This Commander is preset at the factory to turn the display off automatically if you do not operate for more than 10 minutes. You can change the Automatic-Off time from 1 to 30 minutes (page 74).
⏻ is displayed only when transferring the data and lighting the LCD display window.	<ul style="list-style-type: none"> • The batteries begin to be exhausted. Replace the batteries as early as possible (page 7).
The Commander enters the clock setting mode by itself.	<ul style="list-style-type: none"> • The batteries might have been replaced, or the batteries are worn out. Replace the batteries with new ones (page 7). After replacing the batteries, the set contents remain. So, to use the Commander with the previous set contents, you should only set the clock (page 8).
“LOCK” is displayed on the LCD and the display for operation does not appear when you press a button.	<ul style="list-style-type: none"> • The Hold function is on. Unlock the Hold function (page 71).

For the customers in the U.S.A.

Customer Support Information

After you have read through this manual, if you still cannot get the Remote Commander to work properly, call the Sony Customer Support Helpline at 1-800-822-2217.

Table of Preset Functions

Note

There may be some components or functions that cannot be operated with this Commander.

TV

KEY DISPLAY	FUNCTION
POWER	To turn the power on/off
1 - 9, 0, ENTER	To change the channel For example, to change to channel 5, press 0 and 5 (or, press 5 and ENTER)
INPUT	To change the input mode
DISPLAY	To display the current channel on TV
SLEEP	To operate SLEEP function on the TV (works only for a TV with SLEEP function)
MAIN/SUB	To switch the sound of the duplex broadcast
ANT/SW	To switch the multiplex antenna input
WIDE	To switch to WIDE
MENU	To call up the MENU display
⇧	To move the cursor upward
⇩	To move the cursor downward
⇨	To move the cursor to the right
⇦	To move the cursor to the left
OK	To enter the selection of the MENU display
PIP ON/OFF	To turn on/off the "window" picture
PIP CH+/-	To change the TV channel in the "window" picture
PIP INPUT	To change the input mode of the "window" picture
PIP MOVE	To move the location of the "window" picture
PIP STILL	To freeze the "window" picture
PIP SWAP	To swap the "window" picture

KEY DISPLAY	FUNCTION
CHANNEL +/-	Channel up: + Channel down: -
RECALL	To operate JUMP, FLASHBACK or CHANNEL RETURN function on the TV depending on the setting of the TV's manufacturer
VOLUME +/-	Volume up: + Volume down: -
MUTING	To mute the volume on the TV. Press again to turn muting off.
VIDEO1	To select the input source: VIDEO 1
VIDEO2	To select the input source: VIDEO 2
VIDEO3	To select the input source: VIDEO 3
VIDEO4	To select the input source: VIDEO 4
TV TUNER	To return to the TV (to reset the external input)
NORMAL	To return the picture and sound quality to the standard status
PIP AUDIO	To change the sound of the main display and sub display
PIP OFF	To turn off the "window" picture
AU MODE	To select the sound adjusting mode
PIC MODE	To select the picture adjusting mode
CAPTION	To display the CRT screen subtitle

STB (Digital Satellite)

KEY DISPLAY	FUNCTION
POWER	To turn the power on/off
1 - 9, 0, ENTER	To change the channel For example, to change to channel 5, press 0 and 5 (or, press 5 and ENTER)
INPUT	To switch the output of the SAT receiver to the TV (When connecting a TV cable or antenna to the receiver, the output switches between a TV and SAT program)
DISPLAY	To turn on the display
S.INDEX	To bring up the Station Index
INFO	To display program information
FAVORITE	To use the "FAVORITE" function
GUIDE	To bring up Master Guide
ANT/SW	To switch the antenna input in order
*1 ◀◀	To rewind
*1 ▶	To play
*1 ▶▶	To fast-forward
*1 REC	To record, press ▶ while pressing REC. First release ▶, then release REC.
*1 ■	To stop
*1	To pause
MENU	To call up the MENU display
⤴	To move the cursor upward
⤵	To move the cursor downward
⤶	To move the cursor to the right
⤷	To move the cursor to the left
OK	To bring up the Station Index when a program guide is not displayed To select the channel that is highlighted

KEY DISPLAY	FUNCTION
EXIT	To exit the setting menu
CHANNEL +/-	Channel up: + Channel down: -
RECALL	To select the channel previously selected
OUTPUT	Cyclic HDTV output resolution
REPLAY	To replay the built-in DVR
CATEGORY	Category guide
DOT	Decimal point for channel number

*1 The operation of the built-in DVR or the video on demand

**Table of Preset Functions
(continued)**

STB2 (Digital Cable box)

KEY DISPLAY	FUNCTION
POWER	To turn the power on/off
1 - 9, 0, ENTER	To change the channel For example, to change to channel 5, press 0 and 5 (or, press 5 and ENTER)
INPUT	To switch the output of the SAT receiver to the TV (When connecting a TV cable or antenna to the receiver, the output switches between a TV and SAT program)
DISPLAY	To turn on the display
FAVORITE	To use the "FAVORITE" function
*1 ◀◀	To rewind
*1 ▶	To play
*1 ▶▶	To fast-forward
*1 REC	To record, press ▶ while pressing REC. First release ▶, then release REC.
*1 ■	To stop
*1	To pause
MENU	To call up the MENU display
⬆	To move the cursor upward
⬇	To move the cursor downward
⬆	To move the cursor to the right
⬅	To move the cursor to the left
OK	To bring up the Station Index when a program guide is not displayed To select the channel that is highlighted
EXIT	To exit the setting menu
CHANNEL +/-	Channel up: + Channel down: -
RECALL	To turn on the display of a shortcut menu
OPTION	To display the function tag

KEY DISPLAY	FUNCTION
EPG	To call up the title bar and toggle the title bar on/off in CABLE mode
VIEWER	To display a drop menu and toggle to change the user
HOME	To return to the home display from any display
BACK	To return to the just previous display from any display
FWD	To forward the display returned by the BACK key

*1 The operation of the built-in DVR or the video on demand

VCR, VCR2, VCR3

KEY DISPLAY	FUNCTION
POWER	To turn the power on/off
1 - 9, 0, ENTER	To change the channel For example, to change to channel 5, press 0 and 5 (or, press 5 and ENTER)
INPUT	To change the input mode
DISPLAY	To activate the on-screen display
ANT/SW	To switch the antenna output
MAIN/SUB	To switch the sound of the duplex broadcast
MENU	To call up the MENU display
⇧	To move the cursor upward
⇩	To move the cursor downward
⇨	To move the cursor to the right
⇦	To move the cursor to the left
OK	To enter the selection of the MENU display
◀◀	To rewind
▶	To play
▶▶	To fast-forward
REC	To record, press ▶ while pressing REC.* ² First release ▶, then release REC.
■	To stop
	To pause
▲	To eject a cassette
CHANNEL +/-	Channel up: + Channel down: -
COUNTER	To change the counter display
Q.TIMER	To select the recording time by 30 minutes and begin recording
←SEARCH	REVIEW locked picture search
SEARCH→	CUE locked picture search
COMMERCL	To skip over commercials

KEY DISPLAY	FUNCTION
SP/LP	To switch the tape speed
H.S.REW	To rewind at high speed
PLAY x2	To play at double speed
LINE1	To select the input source: LINE 1
LINE2	To select the input source: LINE 2
DVIn	To select the input source: DV
TVTUNER	To return to the TV (to reset the external input)

*² In order to avoid recording by mistake, the REC key does not work by itself. You can assign this operation (record) to a single key using the learning function (page 19).

**Table of Preset Functions
(continued)**

DVD, DVD2

KEY DISPLAY	FUNCTION
POWER	To turn to the power on/off
1 - 9, 0	Number buttons: To set items selected from the screen
+10	To select numbers 10 and above
ENTER	To enter a setting or to set items selected from the screen
AUDIO	To change the sound
DISPLAY	To show the current play status on the screen
ANGLE	To switch angle
CLEAR	To clear the selected characters from the screen
RETURN (RECALL)	To return to the last previous screen
TITLE	To display the title menu
SUB TITLE	To switch the subtitle
A/B	To decide the distance between A and B
MENU	To display the DVD menu
⇧	To move the cursor upward
⇩	To move the cursor downward
⇨	To move the cursor to the right
⇦	To move the cursor to the left
OK	To execute items selected from the screen
⏮	To rewind
▶	To play
⏭	To fast-forward
■	To stop
⏸	To pause
⏭▶ (CH+)	To proceed to the next location or song
⏮◀ (CH-)	To proceed to the previous location or song
⏴	To open or close the tray
TIME	To change the time display
SET UP	To call up the setting up menu

KEY DISPLAY	FUNCTION
REV SLOW	Slow playback in the reverse direction
FWD SLOW	Slow playback in the forward direction
REPEAT	To go into the repeat mode
EDIT	To switch the edit mode to on/off
PLAYMODE	To change the playback mode
DISC	To change a disc
SEARCH→	To search in the forward direction
←SEARCH	To search in the reverse direction
DNR	To change the level of the Digital Noise Reduction
VES	To change the mode of the Virtual Enhanced Surround

CD

KEY DISPLAY	FUNCTION
POWER	To turn the power on/off
1 - 9, 0	To select the track number (0 selects track 10) To select track numbers above 10, see the descriptions on the +10 button below.
+10	To select numbers 10 and above
ENTER	To enter the setting
D.SKIP	To select next disc
DISPLAY	To switch the display of the CD player to on/off
CLEAR	To clear the setting
◀◀	To rewind
▶	To play
▶▶	To fast-forward
■	To stop
	To pause
▲	To open/close
▶▶ (CH+)	To select the next track
◀◀ (CH-)	To select the previous track
CONTINUE	To select continuous play mode
SHUFFLE	To play in random order
PROGRAM	To use for program play
REPEAT	To select repeat play mode

KEY DISPLAY	FUNCTION
DISC	To decide the numeric key operation
TRACK	To decide the numeric key operation
GROUP	To decide the numeric key operation
EDIT	To go into the setting mode of automatic program and time fade
DSP MODE	To toggle the mode of DSP added to the CD
DSP OFF	To turn the DSP off
FADER	To toggle the fade-in/fade-out operation
PLAYMODE	To change the play mode cyclically

**Table of Preset Functions
(continued)**

AMP

KEY DISPLAY	FUNCTION
POWER	To turn the power on/off
1 - 9, 0	Keys to use the tuner directly
ENTER	To enter the setting
VIDEO 1	To select the input source: VIDEO 1
VIDEO 2	To select the input source: VIDEO 2
VIDEO 3	To select the input source: VIDEO 3
AUX	To select the input source: AUX
DVD	To select the input source: DVD
TV	To select the input source: TV
CD	To select the input source: CD
MD/DAT	To select the input source: MD
TUNER	To select the input source: TUNER
TAPE	To select the input source: TAPE
PHONO	To select the input source: PHONO
5.1 INPUT	To change the multi-channel of 5.1ch and above
MENU	To call up the MENU display, or return to the previous MENU
⇧	To move the cursor upward
⇩	To move the cursor downward
⇨	To move the cursor to the right
⇦	To move the cursor to the left
OK	To enter the selection of the MENU display

KEY DISPLAY	FUNCTION
SHIFT	To shift band or preset select
BAND	To select FM/AM
EXIT	To return to the basic MENU
CHANNEL +/-	Presetting or tuning frequency to a higher: + Presetting or tuning frequency to a lower: -
VOLUME +/-	Volume up: + Volume down: -
MUTING	To mute the volume on the AMP Press again to turn muting off
S.FIELD	To turn on/off the sound field
GENRE	To select a sound field genre
MODE	To select a sound field mode
T.TONE	To output a test tone
CENTER+	To adjust the center speaker level: +
CENTER-	To adjust the center speaker level: -
REAR+	To adjust the rear speaker level: +
REAR-	To adjust the rear speaker level: -
SUB WOOFER+	To adjust the subwoofer level: +
SUB WOOFER-	To adjust the subwoofer level: -
←D.INPUT	To switch the digital input: ←
D.INPUT→	To switch the digital input: →

MD

KEY DISPLAY	FUNCTION
POWER	To turn the power on/off
1 - 9, 0	To select the track number (0 selects track 10) To select track numbers above 10, see the descriptions on the +10 button below.
+10	To select numbers 10 and above
ENTER	To enter the setting
D.SKIP	To select the next disc
DISPLAY	To change the display mode or turn the display on/off
CLEAR	To clear the setting
◀◀	To rewind
▶	To play
▶▶	To fast-forward
REC	To record, press ▶ while pressing REC. First release ▶, then release REC.
■	To stop
	To pause
▲	To open/close
▶▶ (CH+)	To select the next track
◀◀ (CH-)	To select the previous track

KEY DISPLAY	FUNCTION
CONTINUE	To select continuous play mode
SHUFFLE	To play in random order
PROGRAM	To use for program play
REPEAT	To switch the repeat play of a single or all track(s) to on/off
DECK A	To select a deck of the dual MD deck: A
DECK B	To select a deck of the dual MD deck: B
RECMODE	To toggle the recording mode
CD-SYNC	To start synchronizing with the CD
FADER	To select the fade-in/fade-out

**Table of Preset Functions
(continued)**

TAPE A, TAPE B

KEY DISPLAY	FUNCTION
POWER	To turn the power on/off
1 - 9, 0	To select the track number
ENTER	To enter the setting
◀◀	To rewind
◀	To reverse
▶	To play
▶▶	To fast-forward
REC	To enter the record standby mode, press REC. To record, press ▶ while pressing REC. To record in reverse, press ◀ while pressing REC.
■	To stop
	To pause
DISPLAY	To change the display mode
A/B	To select a tape deck: Deck A or B (dual cassette deck only)
REW AMS	To search the beginning of a track in the rewind direction
FF AMS	To search the beginning of a track in the fast forward direction
FADER	To stop after fading out and fade in after starting

KEY DISPLAY	FUNCTION
REC MUTE	Record muting
DOLBY NR	To toggle the Dolby Noise Reduction
REC LEVEL+	To make the recording level higher
REC LEVEL-	To make the recording level lower
C.RESET	To reset the tape counter
C.MEMORY	To switch the position memory operation according to the tape counter to on/off
PROGRAM	To go into the program mode by first pressing, and start program play by second pressing

CABLE (Cable box)

KEY DISPLAY	FUNCTION
POWER	To turn the power on/off
1 - 9, 0, ENTER	To change the channel For example, to change to channel 5, press 0 and 5 (or , press 5 and ENTER)
CHANNEL +/-	Channel up : + Channel down : -
RECALL	To operate JUMP, FLASHBACK or CHANNEL RETURN function

LD (Laser disc player)

KEY DISPLAY	FUNCTION
POWER	To turn the power on/off
1 - 9, 0	To select the track number (0 selects track 10) To select track numbers above 10, see the descriptions on the +10 button below
+10	To select numbers 10 and above
ENTER	To enter the setting
DISPLAY	To show the current play status on the screen
CLEAR	To clear the selected characters from the screen
ANT/SW	To switch between the TV and the video
◀◀	To rewind
▶	To play
▶▶	To fast-forward
■	To stop
	To pause
▶▶▶ (CH+)	To proceed to the next location or song
◀◀◀ (CH-)	To proceed to the previous location or song
▲	To open or close the tray
SIDE A	To select disc side A, when the side is selectable
SIDE B	To select disc side B, when the side is selectable
x2/x3	To go into the double or triple speed mode
PROGRAM	To go into the program mode

**Table of Preset Functions
(continued)**

DVR (Digital video recorder)

KEY DISPLAY	FUNCTION
POWER	To turn the power on/off
1 - 9, 0, ENTER	To change the channel For example, to change to channel 5, press 0 and 5 (or, press 5 and ENTER)
INPUT	To switch the output of the SAT receiver to the TV (When connecting a TV cable or antenna to the receiver, the output switches between a TV and SAT program)
DISPLAY	To turn on the display
CLEAR	To clear the setting
GUIDE	To bring up Master Guide
INFO	To display program information
^{*3} THUMBS+	To select the desired recorded program (It is necessary to have recorded the desired program.)
^{*3} THUMBS-	To select the desired recorded program (It is necessary to have recorded the desired program.)
◀◀	To rewind
▶	To play
▶▶	To fast-forward
REC	To record, press ▶ while pressing REC. First release ▶, then release REC. To stop recording, perform the same procedure.
■	To stop
	To pause
MENU	To call up the MENU display
⬆	To move the cursor upward
⬇	To move the cursor downward
⬆	To move the cursor to the right
⬅	To move the cursor to the left

KEY DISPLAY	FUNCTION
OK	To bring up the Station Index when a program guide is not displayed To select the channel that is highlighted
EXIT	To exit the setting menu
CHANNEL +/-	Channel up: + Channel down: -
^{*3} EPG	To access to all aspects of the service
^{*3} REPLAY	To replay Or to go into REC/REVIEW mode during play (After about 5-second rewind, replay begins.)
^{*3} Live TV	To bring up Master Guide
^{*3} LIST	To call up the title of the recorded program
CUE SKIP	To skip over commercials
^{*3} ADVANCE	To end the recorded program instantly
^{*3} PAGE+	Page up: +
^{*3} PAGE-	Page down: -

^{*3} This key corresponds to Tivo service or the replay service. Refer to its instruction manual for details.

DAT

KEY DISPLAY	FUNCTION
POWER	To turn the power on/off
1 - 9, 0	To select the track number (0 selects track 10) To select track numbers above 10, see the descriptions on the +10 button below.
+10	To select numbers 10 and above
ENTER	To enter the setting
D.SKIP	To select the next disc
DISPLAY	To change the display mode or turn the display on/off
CLEAR	To clear the settings
◀◀	To rewind
▶	To play
▶▶	To fast-forward
REC	To record, press ▶ while pressing REC. First release ▶, then release REC.
■	To stop
	To pause
▲	To open/close
▶▶ (CH+)	To select the next track
◀◀ (CH-)	To select the previous track

KEY DISPLAY	FUNCTION
HIGH REV	High speed review
HIGH CUE	High speed cue
FADER	To select the fade-in/fade out
REC MUTE	Record muting

Table of Preset Functions (continued)

LIGHTING

KEY DISPLAY	FUNCTION (Key display of other remote commanders)					
	Lutron					X10
	Spacer	Spacer System	Grafik Eye	RadioRA	Home- Works Interac- tive	
OFF		OFF	OFF	ALL OFF		OFF
1		SCENE1	SCENE1	SCENE1	MACRO1	SCENE1
2		SCENE2	SCENE2	SCENE2	MACRO2	SCENE2
3		SCENE3	SCENE3	SCENE3	MACRO3	SCENE3
4		SCENE4	SCENE4	SCENE4	MACRO4	SCENE4
5			SCENE5	SCENE5	MACRO5	SCENE5
6			SCENE6	SCENE6	MACRO6	SCENE6
7			SCENE7	SCENE7	MACRO7	SCENE7
8			SCENE8	SCENE8	MACRO8	SCENE8
9			SCENE9	SCENE9	MACRO9	SCENE9
10			SCENE10	SCENE10	MACRO10	SCENE10
11			SCENE11	SCENE11	MACRO11	SCENE11
12			SCENE12	SCENE12	MACRO12	SCENE12
SCENE13			SCENE13	SCENE13	MACRO13	SCENE13
SCENE14			SCENE14	SCENE14	MACRO14	SCENE14
SCENE15			SCENE15	SCENE15	MACRO15	SCENE15
SCENE16			SCENE16		MACRO16	SCENE16
ALL ON		FULL ON		ALL ON		ALL ON
ALL OFF				ALL OFF		ALL OFF
ON						ON
OFF						OFF
CHANNEL +	Raise	Raise	Raise	Raise		Raise
CHANNEL -	Lower	Lower	Lower	Lower		Lower
RECALL	Toggle					

Quick Reference of Operations

To	Press	For details, see
Enter the setting mode	COMMANDER OFF + MUTING (If you do not perform any step within two minutes, the mode ends.)	page 12
Enter the learning mode	COMMANDER OFF + Component Select COMMANDER OFF + OTHER	page 19
Enter the setting mode of the System Control function	COMMANDER OFF + SYSTEM CONTROL (1, 2, 3) COMMANDER OFF + MORE	page 32
Enter the timer program setting mode	COMMANDER OFF + TIMER	page 61
Input the character contents to each Label key for the component	COMMANDER OFF + MENU + Component Select COMMANDER OFF + MENU + OTHER	page 79
Input the character contents to each Label key for the System Control	COMMANDER OFF + MENU + MORE	page 79
Input the character contents to each Label keys for the timer program	COMMANDER OFF + MENU + TIMER	page 79
Program the Power-on command	COMMANDER OFF + VOLUME- + Component Select COMMANDER OFF + VOLUME- + OTHER (To reset the command, repeat the procedure.)	page 43
Set the Channel Macro function	COMMANDER OFF + CHANNEL+ + Component Select COMMANDER OFF + CHANNEL+ + OTHER	page 58
Transfer/receive the data	COMMANDER OFF + VOLUME- + CHANNEL-	page 52
Change the volume control setting	COMMANDER OFF + VOLUME+ + VOLUME-	page 29
Copy the setting of a Component	COMMANDER OFF + ↕	page 47

Quick Reference of Operations (continued)

To	Press	For details, see
Set the interval between operation steps of the System Control Set the component macro executing time	COMMANDER OFF + EXIT	page 40, 42
Adjust the contrast of the LCD display window	COMMANDER OFF + OK	page 78
Turn the key-touch beep on/off	COMMANDER OFF + MUTING ↓ (ON) MUTING + VOLUME+ (OFF) MUTING + VOLUME-	page 77
Set the Automatic-Off time of the LCD display window	COMMANDER OFF + VOLUME- + CHANNEL+	page 73
Set the Automatic-Off time	COMMANDER OFF + LIGHT	page 74
Set the brightness of the backlight	COMMANDER OFF + LIGHT + VOLUME+	page 74
Select the buttons to light the LCD display window	COMMANDER OFF + LIGHT + VOLUME-	page 74
Set the STD (standard) time	Clock Display + CHANNEL-	page 8, 11
Set the DS (daylight saving) time	Clock Display + CHANNEL+	page 8, 11
Set the clock	Clock Display + RECALL	page 10
Lock the Remote Commander	Clock Display + COMMANDER OFF	page 23
Unlock the Remote Commander	COMMANDER OFF (Keep the button pressed for more than 2 seconds.)	page 71

Full Display

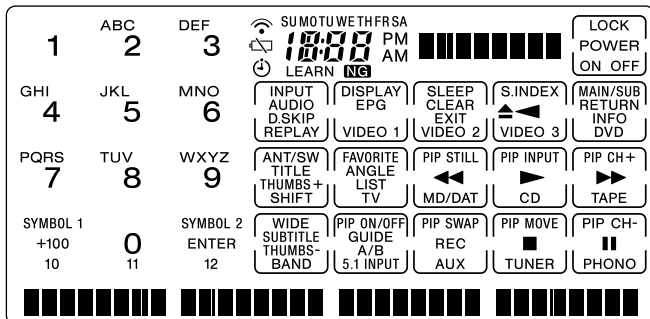

Index

A

- Automatic-Off
 - of the backlight 74
 - of the display window 73

B

- Backlight
 - adjusting 74
 - Automatic-Off 74
- Batteries 7

C, D

- Changing
 - component name on the Mode display key 24
 - function display of keys 23
 - interval of the System Control function 40
 - name of the Label key 23
- CHANNEL button 6
- Channel Macro function 58
- Clearing/Changing
 - Channel Macro function 60
 - learned signal 25, 46, 51
 - System Control function 35, 39
 - timer setting 67, 70
- Clock setting 8
 - DS time 8, 11
 - STD time 8, 11
- Code number 13

- Component Select buttons
 - assigning other components 47
 - copying settings 47
 - programming a signal 43

- programming System Control function 38
- receiving data 56
- setting Power-On function 43
- transferring data 52
- COMMANDER OFF button 6
- Copying
 - settings of Component Select buttons 47

E

- Erasing
 - all the settings 81
 - See "Clearing/Changing"

F, G

- Factory setting 12, 29, 37

H

- Hold Function 71

K

- Key touch beep 77

L

- LCD
 - brightness 74
 - full display 103
- Learning Function 19, 45, 49
- LIGHT button 6, 74
- Locking
 - control of Commander 71
 - settings on Commander 72

M, N, O

- MUTING button 6, 19, 22

P, Q

- Power-On function
 - setting 43
 - SYSTEM CONTROL3 button 37
- Power-Off function
 - See "System Power-Off function"
- Preset components 12

R

- Receiving data 56

S

- Setting Lock function 72
- SYSTEM CONTROL
 - buttons 7
 - programming a signal 49
 - programming System control function 31
- System Control function
 - changing interval 40
 - clearing 35, 37, 39
- System Power-Off function
 - SYSTEM CONTROL 1 button 37

T, U

- Timer setting 61
- Transferring data 52
- Troubleshooting 84

V, W, X, Y, Z

- VOLUME buttons 6, 19, 22
- Volume Control 19, 29